



# EZZO COLLECTION DOORS, WINDOWS & SKYLIGHTS

Designed for Light, Built for Living

Product Catalogue 2026



Bartley Biz Centre  
Blk 15 Kaki Bukit Rd 4, #01-44 Singapore 417808  
[admin@ezzogenics.com](mailto:admin@ezzogenics.com) | [david@ezzogenics.com](mailto:david@ezzogenics.com)

[www.ezzo.sg](http://www.ezzo.sg)

# About Our Company



EZZODOORS is a premium brand under Ezzogenics, specializing in high-quality modern aluminum windows and doors. We bring together advanced manufacturing technology, architectural expertise, and meticulous craftsmanship to deliver products that enhance both the aesthetics and functionality of any space.

**100 +**  
**PROJECTS**  
**COMPLETED**



With a focus on sustainability, innovation, and customer satisfaction, EZZODOORS has established itself as a trusted name in the industry. We don't just supply windows and doors—we deliver complete solutions backed by professional installation services and ongoing support.

# Product Features

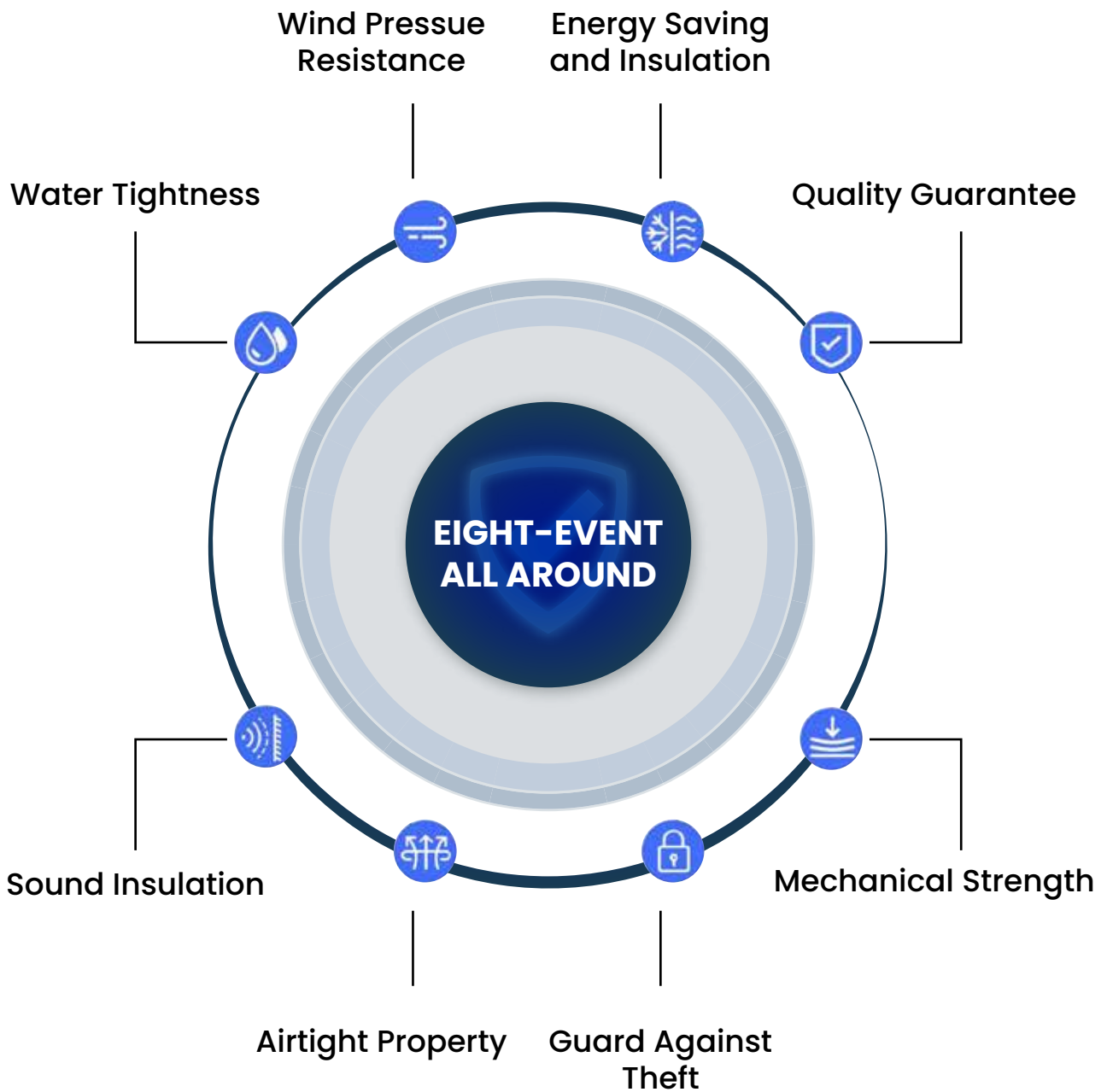

# Customer Service Process Flow



## Initial Communication Phase

Customer Inquiry ▶ Requirement ▶ Site Visit ▶ Quotation



## Order Execution Phase

Contract Signing ▶ Make Deposit ▶ Production Scheduling



## Production Phase

Manufacturing ▶ Quality Inspection ▶ Acceptance

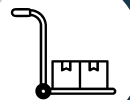

## Delivery Phase

Packing & Shipping ▶ Customs Clearance ▶ Delivery & Receipt

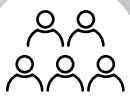

## On-site Installation Phase

Supply Labor ▶ Installation Guidance ▶ Customer Acceptance



## After-sales Service

After-sales Service ▶ Requirement Updates ▶ Repeat Cooperation

# Table of CONTENTS



## SYSTEM WINDOW SERIES

Casement window (PRO110/590/120 series, curtain wall window) .....	8 - 13
Sliding window (112/123 series, 130side pressure window) .....	14 - 19
Folding window (65/40/55/60 Series) .....	20 - 24
American window (50/70/83 series) .....	25 - 27
Electric lift window (125/158 series) .....	28 - 29

## SYSTEM DOOR SERIES

Heavy Sliding Door (E190/E127/TY120/TY150 series, 180 arc series) .....	31 - 39
Folding Door (65/68/80 series) .....	40 - 46
Flat Door (120 series, aluminium louvre, floor spring door) .....	47 - 49
PT Doors .....	50 - 54
Interior Doors (08 single glazing sliding door, 08 single glazing flat door, french door, central shaft door) .....	55 - 59
Room Door (aluminum wood door, all aluminum door) .....	60 - 63

<b>ENGINEERING PRODUCT</b> .....	<b>68 - 85</b>
----------------------------------	----------------

<b>SKYLIGHTS</b> .....	<b>86 - 97</b>
------------------------	----------------

## INTERIOR DOORS

Italian Cloud Mirror Series .....	102 - 116
Italian Light and Shadow Series .....	117 - 130
Italian checkered series .....	131 - 138
French Warm Oil Wind Series .....	139 - 143
Italian agile series .....	144 - 147
Italian Muli serie .....	148 - 151
Italian Infinite Wind Series .....	152 - 157

# SYSTEM WINDOW SERIES





Special design style to create different home atmospheres and discover unexpected beauty.

Both function and beauty are emphasised, with a narrower border, a more minimalist appearance, and a delicate touch.

## Multiple Opening Methods





# PRO110

CASEMENT WINDOW

## PRODUCT PARAMETER

**Profile Wall Thickness**

2.0 mm

**Frame Width**

110 mm

**Opening Options**

Outward Swing/Inward Swing/ Inward Tilt & Swing / Swing Door

## STANDARD CONFIGURATION

**Profile Configuration**

National Standard 6063-T5 Aluminum Alloy

**Hardware System**

CMECH Hardware

**Glass Configuration**

5+20A+5mm Tempered Insulated Glass

**Screen Mesh**

0.45 High-Definition Mesh

**Thermal Barrier**

PA66 Nylon Thermal Break

**Shading System**

Glass Blinds / Windproof Roller Blinds

**Optional Glass Types**

LOW-E/Coated / Smart/ Tinted Glass



BUILDING A REASONABLE  
SENSE OF ORDER FOR  
MINIMALISM WITH SIMPLE  
YET EXTRAORDINARY  
DETAILS, CREATING EVERY  
BIT OF BEAUTY IN LIFE





# E-120

CASEMENT WINDOW

## PRODUCT PARAMETER

**Profile Wall Thickness**

20mm/50mm

**Frame Width**

120 mm

**Opening Options**

Outward Swing/Inward Swing/Inward Swing with Tilt/Swing Door

## STANDARD CONFIGURATION

**Profile Configuration**

National Standard 6063-T5 Aluminum Alloy

**Hardware System**

CMECH Hardware

**Shading System**

Glass Blinds / Windproof Roller Blinds

**Screen Mesh**

0.45 High-Definition Mesh

**Optional Glass Types**

LOW-E/Coated / Smart/ Tinted Glass

**Glass Configuration**

5+20A+5mm Tempered Insulated Blacksmith

**Thermal Barrier**

PA66 Nylon Thermal Break



Designing with intention,  
embracing simplicity, and  
revealing beauty through  
refined details.





# S-90

## CASEMENT WINDOW

### PRODUCT PARAMETER

**Profile Wall Thickness**

1.8mm

**Frame Width**

90 mm

**Opening Options**

Inward Swing, Double Inward Swing, Inward swing with Tilt Tum

### STANDARD CONFIGURATION

**Profile Configuration**

National Standard 6063-T5 Aluminum Alloy

**Hardware System**

CMECH Hardware

**Shading System**

Glass Blinds / Windproof Roller Blinds

**Screen Mesh**

0.45 High-Definition Screen / Folding Screen Mesh

**Optional Glass Types**

LOW-E / Coated / Smart / Tinted Glass

**Glass Configuration**

Triple Glazing: 5mm + 12A + 5mm + 12A + 5mm

**Thermal Barrier**

PA66 Nylon Thermal Break

Double Glazing: 5mm + 20A + 5mm



**DOUBLE INWARD OPENING DESIGN  
AFETY FIRST EASY TO CLEAN**

Triple-Glass Dual-Chamber Configuration: Featuring a triple-glass setup (5+12A+5+12A+5) and a double-glass option (5+20A+5) delivering exceptional sound insulation and thermal efficiency.



**Featured Imported Hardware**

CMECH handle, over tens of thousands of safe openings and closures. Won the German Red Dot Design Award.



**Featured Imported Hardware**

CMECH handle, over tens of thousands of safe openings and closures. Won the German Red Dot Design Award.

**S-90**

CASEMENT WINDOW

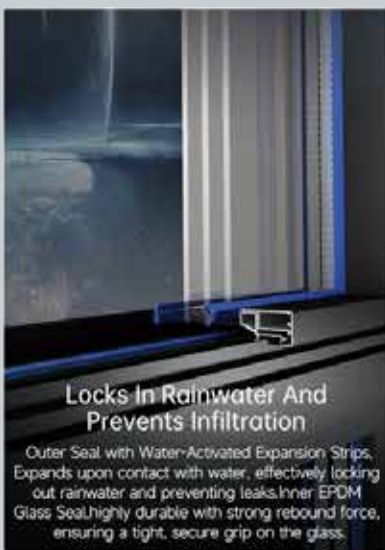

**Locks In Rainwater And Prevents Infiltration**

Outer Seal with Water-Activated Expansion Strips. Expands upon contact with water, effectively locking out rainwater and preventing leaks. Inner EPDM Glass Seal, highly durable with strong rebound force, ensuring a tight, secure grip on the glass.



**Multiple Sealing Strips**

Three seal design, equipped with automotive grade EPDM EPDM compound foam rubber strip, the middle duck-bill glue fully play the role of rain curtain principle to make the product has good air tightness and water tightness.



# 112

## SLIDING WINDOW

### PRODUCT PARAMETER

**Profile Wall Thickness**

1.4 mm

**Frame Width**

112 mm

**Opening Options**

Push-And-Pull

### STANDARD CONFIGURATION

**Profile Configuration**

National Standard 6063-T5 Aluminum Alloy

**Screen Mesh**

0.45 High-Definition Screen / Folding Screen Mesh

**Optional Glass Types**

LOW-E / Coated / Smart / Tinted Glass

**Hardware System**

EMD System

**Glass Configuration**

5mm + 12A + 5mm Tempered Insulated Glass

**Shading System**

Glass Blinds / Windproof Roller Blinds

**Thermal Barrier**

PA66 Nylon Thermal Break

# 112

## SLIDING WINDOW

IN MODERN LIFE, WE ARE CONSTANTLY SURROUNDED BY NOISE AND DISTRACTIONS. ONLY A FEW PEOPLE CAN TRULY SLOW DOWN AND EXPERIENCE THE IMAGINATION, CALM, AND RELAXATION THAT MINIMALIST LIVING BRINGS.





# 123

BROKEN BRIDGE  
SUSPENSION  
SLIDING WINDOW

## PRODUCT PARAMETER

**Profile Wall Thickness**

2.0 mm

**Frame Width**

123 mm

**Opening Options**

Push-And-Pull

## STANDARD CONFIGURATION

**Profile Configuration**

National Standard 6063-T5 Aluminum Alloy

**Screen Mesh**

0.45 High-Definition Screen / Folding Screen Mesh

**Optional Glass Types**

LOW-E / Coated / Smart / Tinted Glass

**Hardware System**

EMD System

**Glass Configuration**

5mm + 15A + 5mm Tempered Insulated Glass

**Shading System**

Glass Blinds / Windproof Roller Blinds

**Thermal Barrier**

PA66 Nylon Thermal Break



# 123 BROKEN BRIDGE SUSPENSION SLIDING WINDOW

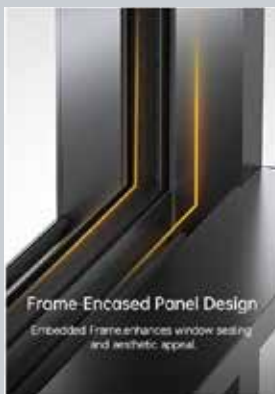

**Frame-Encased Panel Design**  
Embedded frame enhances window sealing and aesthetic appeal.



**Excellent Drainage Structure**  
The 123 Series sliding window features a track with long-slantedly continuous slip-shaped drainage holes, reducing water accumulation on the surface. The outer track arm is equipped with a drainage cover incorporating a check valve, ensuring excellent drainage performance even during heavy rains.



**9mm Ultra-Slim Cable Channel**  
The linear track design delivers a sleek, beamless visual profile, with the track's groove width minimized to an ultra-compact 9mm.



**Reinforced Slim Hook Design**  
Seamlessly blends aesthetics with sturdiness, featuring a slim 34mm visible frame profile. Reinforced with multiple sealing strips and aluminum-treated finish strips, it effectively reduces air convection within the cavity.

# 130

## SIDE PRESS WINDOW



### PRODUCT PARAMETER

**Profile Wall Thickness**

2.0 mm

**Frame Width**

130 mm

**Opening Options**

Push-And-Pull

### STANDARD CONFIGURATION

**Profile Configuration**

National Standard 6063-T5 Aluminum Alloy

**Screen Mesh**

0.45 High-Definition Screen / Folding Screen Mesh

**Optional Glass Types**

LOW-E / Coated / Smart / Tinted Glass

**Hardware System**

EMD System

**Glass Configuration**

5mm + 20A + 5mm Tempered Insulated Glass

**Shading System**

Glass Blinds / Windproof Roller Blinds

**Thermal Barrier**

PA66 Nylon Thermal Break



MINIMAL IN FORM,  
POWERFUL IN  
PRESENCE—WHERE  
THOUGHTFUL DETAILS  
TRANSFORM SIMPLICITY  
INTO TIMELESS BEAUTY.



Sliding Compression

Customizable to Meet User Needs: Supports Both Floor Mounted and Standard Side Pressure Options. Operation: Side pressure sliding with open swing design, featuring integrated interior pressure lines and glass railings.



Rolling Screen Mesh Design

Space-saving and Unobstructed Views: The screen panel retracts into the frame, utilizing frame pressure to secure it seamlessly, eliminating any color mismatch issues.



Enjoy The Scenery

Side Pressure Opening Design



Glass Railing Design with Optional Security Screen Door

Integrated Falcone Space Mesh™: Offers sleek styling, aesthetics, and functionality—supporting any window style. Features microprint design, exceptional durability, and effortless cleaning.



# 65

## FOLDING WINDOW

### PRODUCT PARAMETER

**Profile Wall Thickness**

2.0 mm

**Frame Width**

65 mm

**Opening Options**

Push-And-Pull

**Single Fan Size Limit**

Maximum width: 700 mm

Maximum height: 2500 mm

### STANDARD CONFIGURATION

**Profile Configuration**

National Standard 6063-T5 Aluminum Alloy

**Thermal Barrier**

PA66 Nylon Thermal Break

**Optional Glass Types**

LOW-E / Coated / Smart / Tinted Glass

**Screen Mesh**

0.45 High-Definition Screen / Folding Screen Mesh

**Glass Configuration**

5mm + 20A + 5mm Tempered Insulated Glass

**Hardware System**

KERSSENBERG

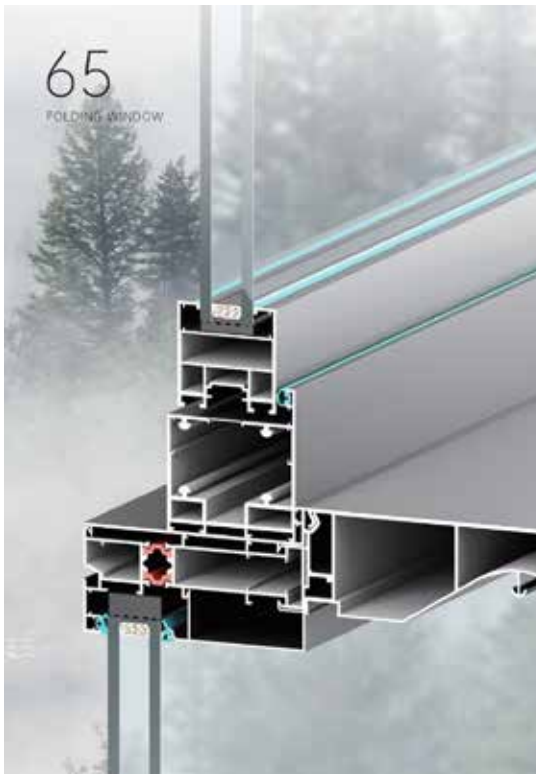

EVERY HEART HOLDS A WORLD OF EMOTIONS. THE EZZODOORS FOLDING WINDOW SERIES, INSPIRED BY COLLAGE ART, BRINGS LIGHT, SPACE, AND FEELING TOGETHER—TURNING YOUR HOME INTO A PLACE WHERE LIFE BEAUTIFULLY INTERSECTS.





# 40

FOLDING WINDOW

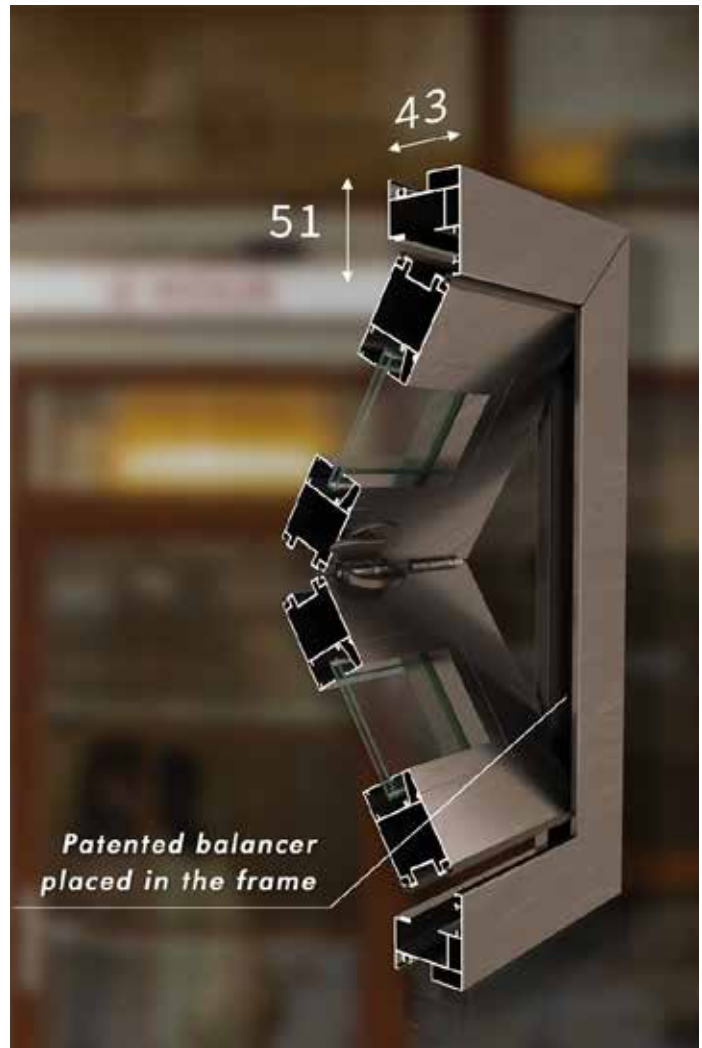

Reference size: 2.5m<sup>2</sup>

Aluminium thickness: 1.2-2.0mm

Can be made without bottom frame | Stop at any height

Cost-effective and most popular



# 55

## FOLDING WINDOW

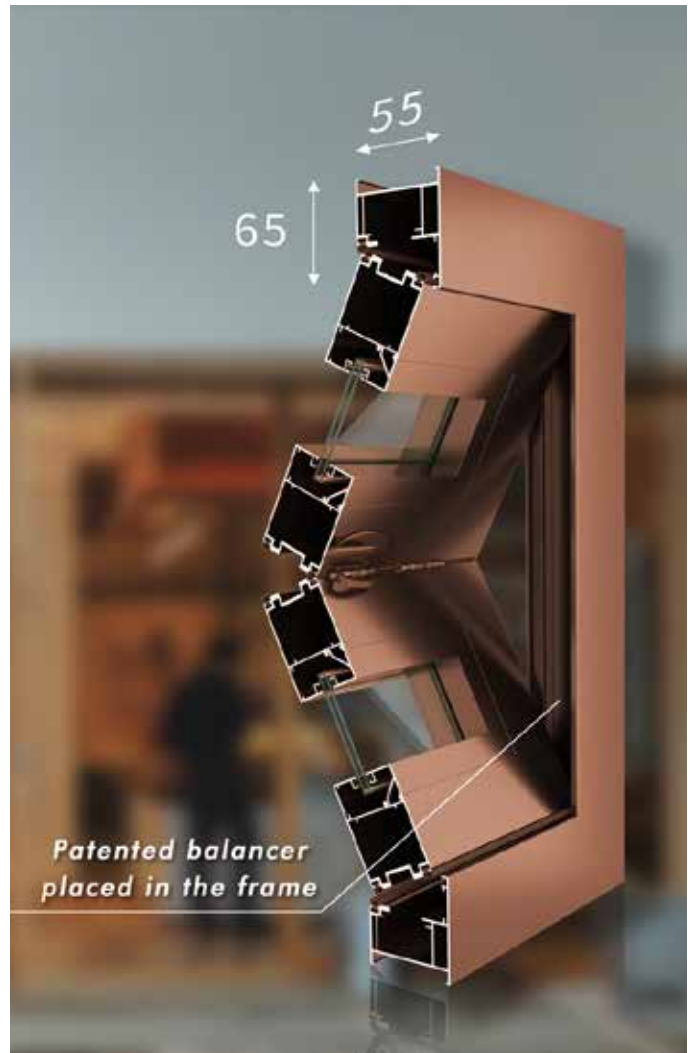

Reference size: 7m<sup>2</sup>

Aluminium thickness: 1.4-3.0mm

Can be made without bottom frame | Stop at any height

Various colours



# 60

## FOLDING WINDOW

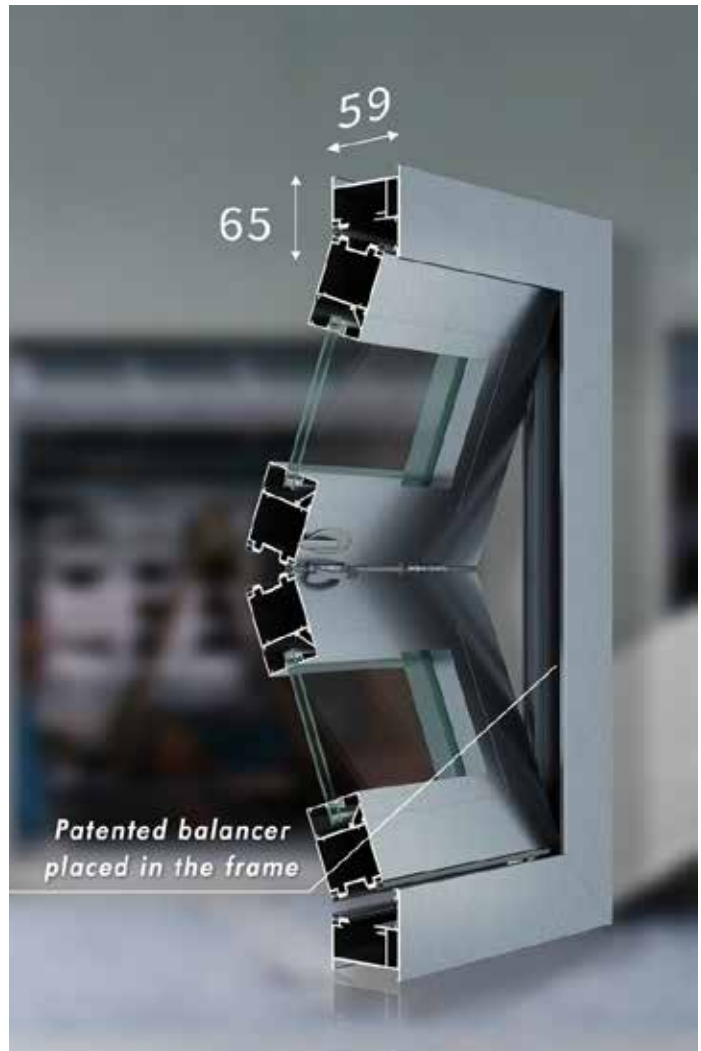

Reference size: 10m<sup>2</sup>

Aluminium thickness: 2.0-3.0mm

Can be made without bottom frame | Stop at any height

Largest size in the folding series



Patented balancer placed in the frame

# 50

## SINGLE-HUNG WINDOW

Reference size: 1.8m<sup>2</sup>

Aluminium thickness: 1.2-1.4mm

Can be made without bottom frame | Stop at any height

Movable sash on the bottom or top /  
One sash with a tilting feature

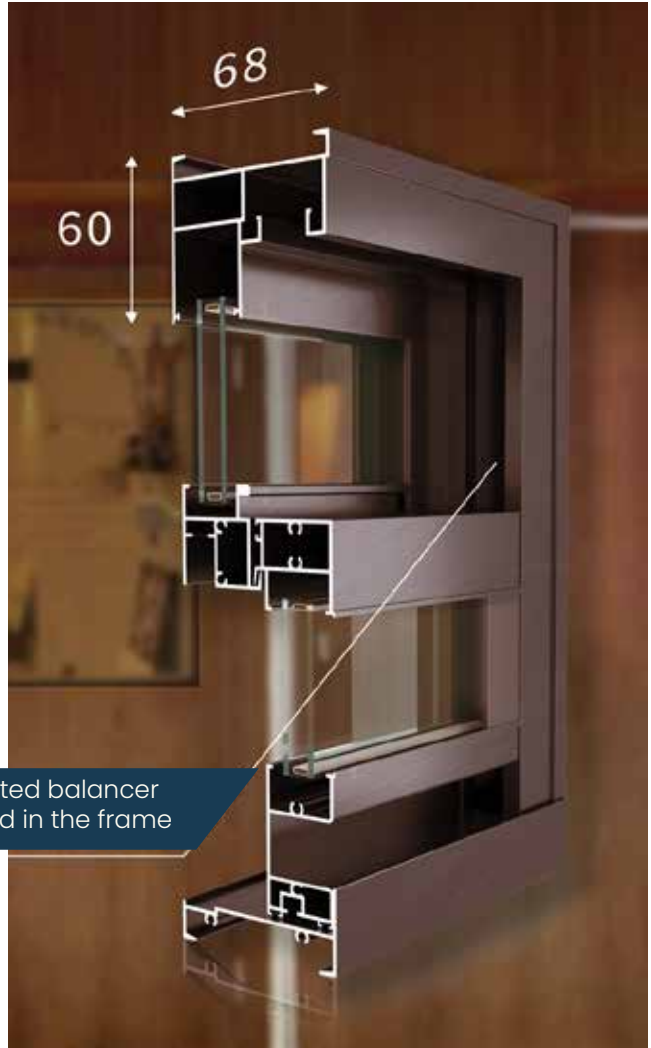

# 70

Patented balancer placed in the frame

## SINGLE-HUNG WINDOW

Reference size: 7m<sup>2</sup>

Aluminium thickness: 1.4-1.6mm

Can be made without bottom frame | Stop at any height

Movable sash on the bottom or top /  
One sash with a tilting feature

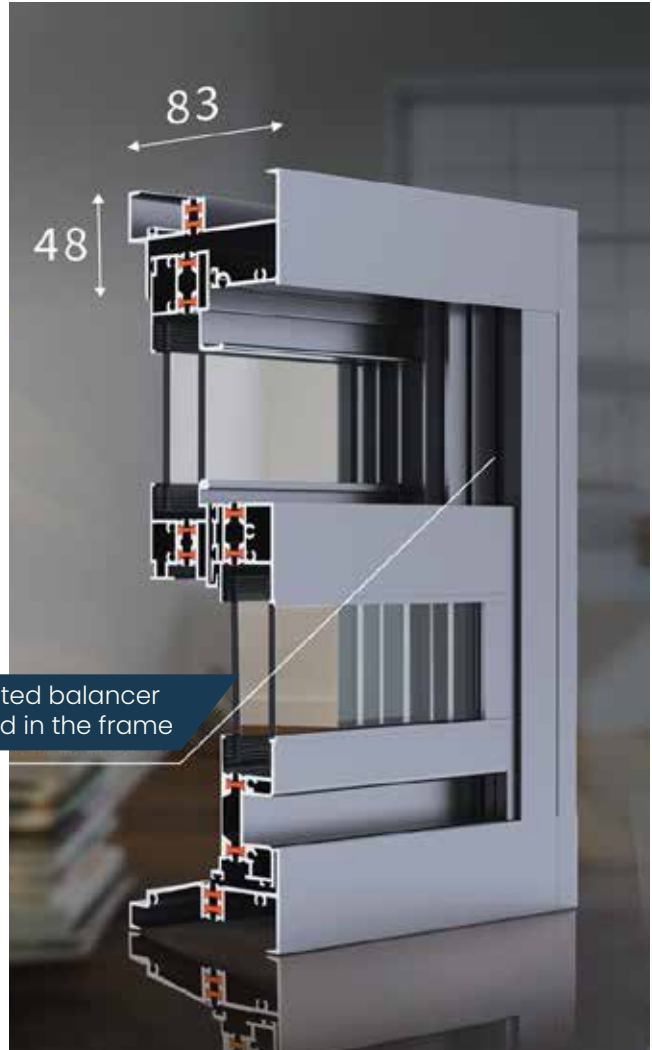

# 83

THERMAL BREAK SYSTEM  
DOUBLE-HUNG WINDOW

Reference size: 2.5m<sup>2</sup>

Aluminium thickness: 1.5mm

Can be made without bottom frame | Stop at any height

Two movable sashes /  
Upper and lower sash with a tilting feature



# 125

MINIMALIST INTELLIGENT  
SINGLE-HUNG WINDOW



Window and mesh integrated | Width not more than 3m

Three types of protection | Child lock | Extremely quiet running

Upgraded to an extremely narrow design



# 158

MINIMALIST INTELLIGENT  
SINGLE-HUNG WINDOW

Window and mesh integrated | Width not more than 4.2m

Three types of protection | Child lock | Extremely quiet running

An upgrad of the 168 series |  
Extremely narrow handrail surface

# SYSTEM DOOR SERIES





# 127

SLIDING DOOR

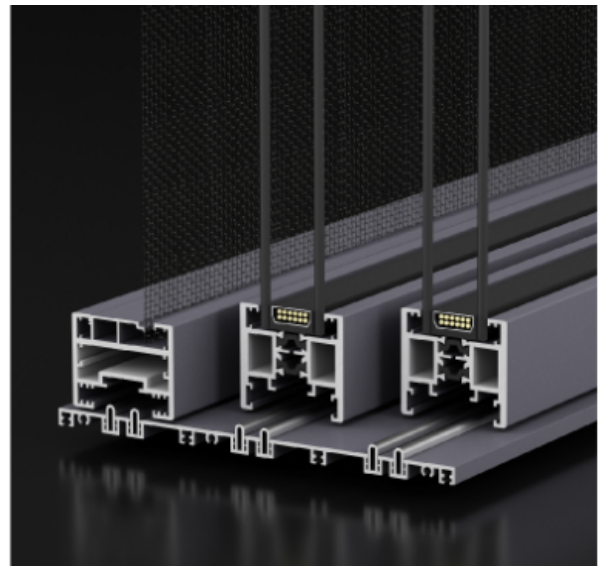

# 190

SLIDING DOOR

## PRODUCT PARAMETER

### Profile Wall Thickness

4.0 mm

### Frame Width

127/190 mm

### Opening Options

Push-And-Pull

## STANDARD CONFIGURATION

### Profile Configuration

National Standard 6063-T5 Aluminum Alloy

### Screen Mesh

0.45 High-Definition Screen / Folding Screen Mesh

### Optional Glass Types

LOW-E / Coated / Smart / Tinted Glass

### Hardware System

EMD System

### Glass Configuration

5mm + 20A + 5mm Tempered Insulated Glass

### Shading System

Glass Blinds / Windproof Roller Blinds

### Thermal Barrier

PA66 Nylon Thermal Break

### Lower Track Configuration

High Track With Water Barrier / Low Track



WHERE INNOVATION MEETS  
ELEGANCE—EZZODOORS  
REDEFINES SPATIAL  
PARTITIONS WITH SEAMLESS  
TRANSITIONS, LIGHTWEIGHT  
DESIGN, AND REFINED  
AESTHETICS.

127/190  
SLIDING DOOR





# TY120

## SLIDING DOOR

### PRODUCT PARAMETER

#### Profile Wall Thickness

Frame: 2.0 mm | Door Panel: 2.0 -4.0 mm |  
Hook Rail: 3.0 mm - 6.00 mm

#### Frame Width

120 mm

#### Opening Options

Push-And-Pull

#### Maximum Height

Height within 4m

### STANDARD CONFIGURATION

#### Profile Configuration

National Standard 6063-T5 Aluminum Alloy

#### Screen Mesh

Diamond Mesh / Folding Gauze

#### Optional Glass Types

LOW-E / Coated / Smart / Tinted Glass

#### Hardware System

EMD System

#### Glass Configuration

5mm + 20A + 5mm Tempered Insulated Glass

#### Shading System

Glass Blinds / Windproof Roller Blinds

#### Thermal Barrier

PA66 Nylon Thermal Break

#### Lower Track Configuration

High Track With Water Barrier / Low Track

# TY120

SLIDING DOOR

## Industry first

The lower rail adopts a high and low slope  
Designed for smoother drainage



MINIMAL IN FORM,  
POWERFUL IN  
PRESENCE—WHERE  
THOUGHTFUL DETAILS  
TRANSFORM SIMPLICITY  
INTO TIMELESS BEAUTY.

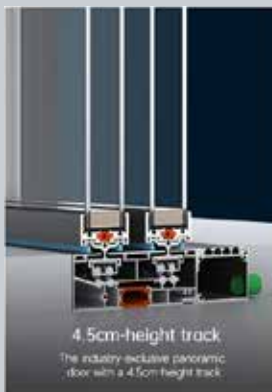

**4.5cm-height track**  
The industry-exclusive panoramic floor with a 4.5cm-height track.



**Retractable Insect Screen**  
The side sash can be equipped with a retractable insect screen.

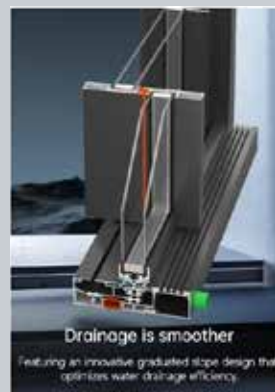

**Drainage is smoother**  
Featuring an innovative graduated slope design that optimizes water drainage efficiency.

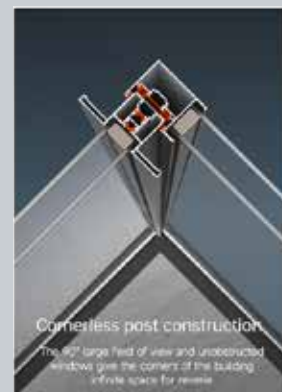

**Cornerless post construction**  
The 90° large field of view and unobstructed windows give the corners of the building infinite space for reuse.



A DISTINCTIVE DESIGN LANGUAGE THAT SHAPES UNIQUE HOME ATMOSPHERES WHILE REVEALING UNEXPECTED BEAUTY. WITH A PERFECT BALANCE OF FUNCTION AND AESTHETICS, THE DESIGN FEATURES SLIMMER FRAMES AND A REFINED MINIMALIST TOUCH.

## TY120

SLIDING DOOR





# TY150

SLIDING DOOR

## PRODUCT PARAMETER

**Profile Wall Thickness**

5.0mm

**Frame Width**

150 mm

**Opening Options**

Push-And-Pull

**Maximum Height**

Height within 7m

## STANDARD CONFIGURATION

**Profile Configuration**

National Standard 6063-T5 Aluminum Alloy

**Screen Mesh**

Diamond Mesh / Folding Gauze

**Optional Glass Types**

LOW-E / Coated / Smart / Tinted Glass

**Hardware System**

EMD System

**Glass Configuration**

5mm + 27A + 5mm Tempered Insulated Glass

**Shading System**

Glass Blinds / Windproof Shutter

**Thermal Barrier**

PA66 Nylon Thermal Break

**Lower Track Configuration**

High Track With Water Barrier / Low Track

# TY150

SLIDING DOOR

- Barrier-free passage, safer
- Linear embedded track design
- Watertight, airtight performance is outstanding
- Better sound insulation
- Track optional marble, tile, rock board, Wooden floor, with the ground integrated, It further exudes the grandeur of a luxury mansion.

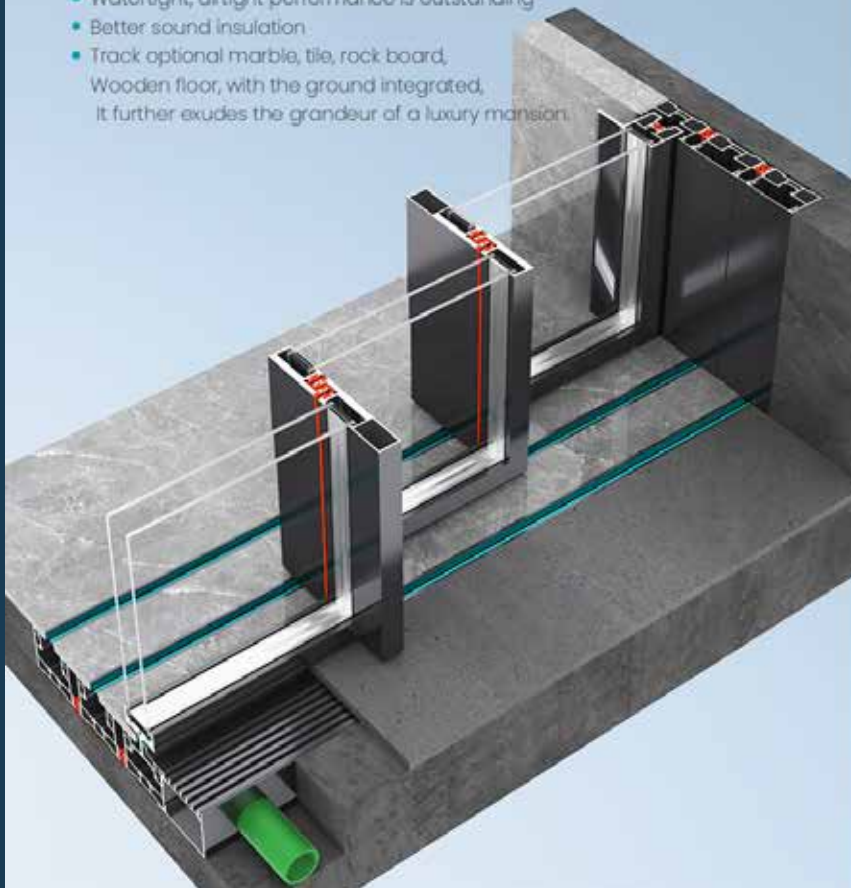

**Barrier-Free Passage,  
More User-Friendly**

Track with marble, optional tile, wood floor, rock, etc. More compatible with the ground.



**Six-Fold Seal**

Seal track, attractive glass, rubber, drip seal, excellent sealing performance.



**More Stable, More Secure**

Adopt the middle fixed, both sliding / both sides fixed, the middle sliding functions.



**Drainage is smoother**

The vertical drainage design with a large bottom slope ensures smoother drainage and leaves no water dripping.



A DISTINCTIVE DESIGN THAT  
CREATES UNIQUE HOME  
ATMOSPHERES AND REVEALS  
UNEXPECTED BEAUTY—COMBINING  
FUNCTIONALITY WITH ELEGANCE  
THROUGH SLIMMER FRAMES AND  
REFINED MINIMALIST DETAILS.

## TY150 SLIDING DOOR



# ARC DOORS



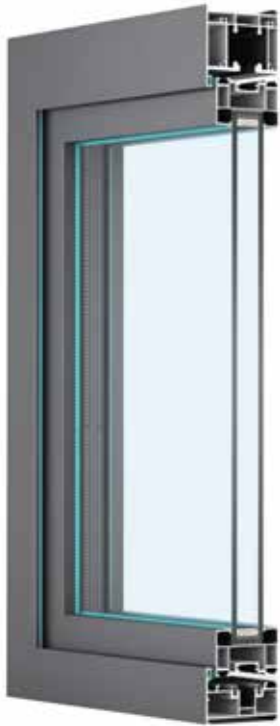

# 65

## HEAVY TYPE FOLDING DOOR

### PRODUCT PARAMETER

**Profile Wall Thickness**

2.0 mm

**Frame Width**

65 mm

**Opening Options**

Push-And-Pull

### STANDARD CONFIGURATION

**Profile Configuration**

National Standard 6063-T5 Aluminum Alloy

**Thermal Barrier**

PA66 Nylon Thermal Break

**Optional Glass Types**

LOW-E / Coated / Smart / Tinted Glass

**Hardware System**

KERSSENBERG

**Glass Configuration**

5mm + 20A + 5mm Tempered Insulated Glass

# HARDWARE CONFIGURATION



Swing Lock (optional)



Sword-Type Lock



Lock Cylinder (optional)



Optional Lock Body (optional)



Automatic Bolt



Handle Hinge



Single Hinge



Top Guide Wheel



Bottom Wheel



Hanger Wheel

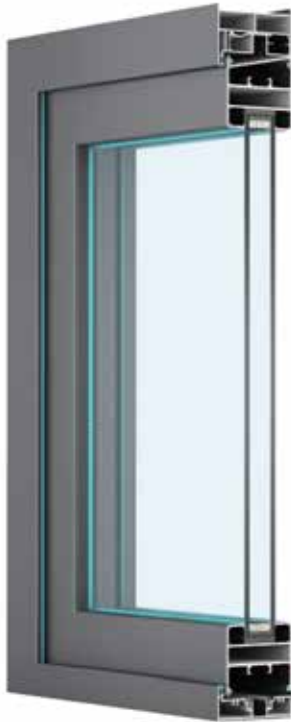

# 68KSBG

NON-THERMAL BREK,  
ANTI-PINCH HEAVY  
DUTY FOLDING DOOR

## PRODUCT PARAMETER

### Profile Wall Thickness

2.0 mm

### Frame Width

68 mm

### Opening Options

Push-And-Pull

### Single Fan Size Limit

Maximum Width 850 mm  
Maximum Height 3600 mm

## STANDARD CONFIGURATION

### Profile Configuration

National Standard 6063-T5 Aluminum Alloy

### Thermal Barrier

PA66 Nylon Thermal Break

### Optional Glass Types

LOW-E / Coated / Smart / Tinted Glass

### Hardware System

KERSSENBERG

### Glass Configuration

5mm + 20A + 5mm Tempered Insulated Glass

HARDWARE CONFIGURATION



Single Side Handle Lock



Handle



Lock Body



Auto Top & Bottom Bolts

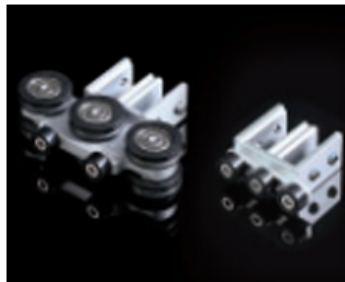

3+1 Bottom WHEELS  
Top Wheel



Hinge



Double-Side Handle Lock  
(optional)



Double-Side Handle Lock  
(optional)



Lock Body with Core  
(optional)



Double Hanger Wheels  
(optional)



Hanger Wheels  
(optional)



2+0, 3+1 Steel Wheels  
(optional)



# 68KSBG

NON-THERMAL BREK,  
ANTI-PINCH HEAVY DUTY FOLDING DOOR

## **PINCH-FREE DESIGN, SPACIOUS INTERIOR**

Meticulous details showcase quality and care.  
Superior stain resistance ensures effortless  
maintenance.

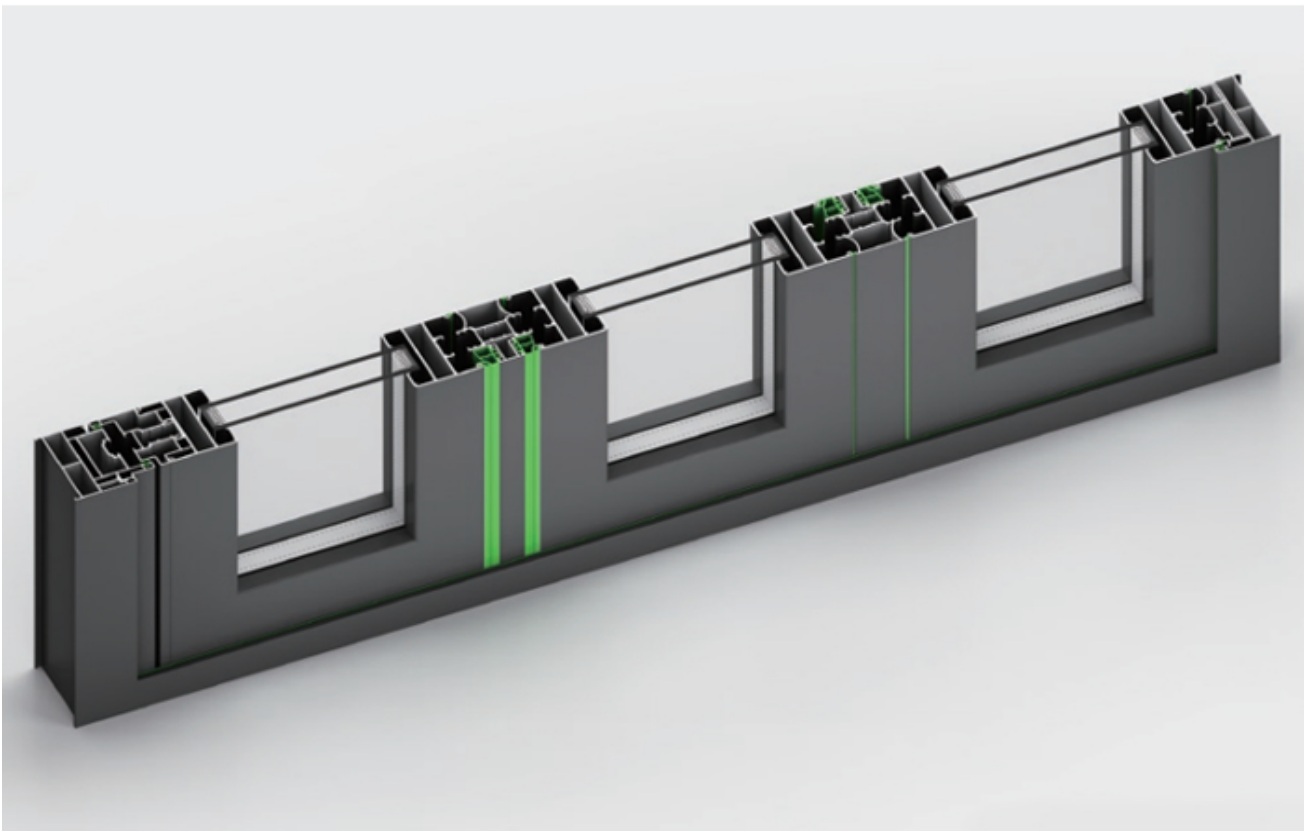

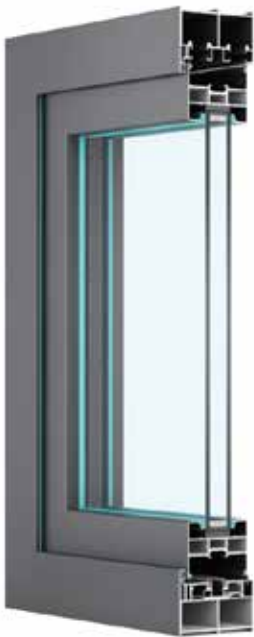

# 80KSBG

NON-THERMAL BREK,  
ANTI-PINCH HEAVY  
DUTY FOLDING DOOR



## PRODUCT PARAMETER

### Profile Wall Thickness

2.0 mm

### Frame Width

80 mm

### Opening Options

Push-And-Pull

### Single Fan Size Limit

Maximum Width 900 mm  
Maximum Height 4800 mm

## STANDARD CONFIGURATION

### Profile Configuration

National Standard 6063-T5 Aluminum Alloy

### Thermal Barrier

PA66 Nylon Thermal Break

### Optional Glass Types

LOW-E / Coated / Smart / Tinted Glass

### Hardware System

KERSSENBERG

### Glass Configuration

5mm + 27A + 5mm Tempered Insulated Glass

### Screen Mesh

0.45 High-Definition Screen / Folding  
Screen Mesh

HARDWARE CONFIGURATION



Single Side Handle Lock



Handle



Lock Body



3+1 Bottom WHEELS  
Top Wheel



Hinge



2+0 Hanger Wheel  
System



Double-Side Handle Lock  
(optional)



Double-Side Handle Lock  
(optional)



Lock Body with Core  
(optional)



Double Hanger Wheels  
(optional)



Hanger Wheels  
(optional)



2+0, 3+1 Steel Wheels  
(optional)



## 120 OUTDOOR FLAT DOOR

NOT LIMITED TO LIMITED SPACE, WHEN A SENSE OF STRUCTURE INTERVENES LIGHT AND SHADOW ADD DEPTH TO THE SPACE

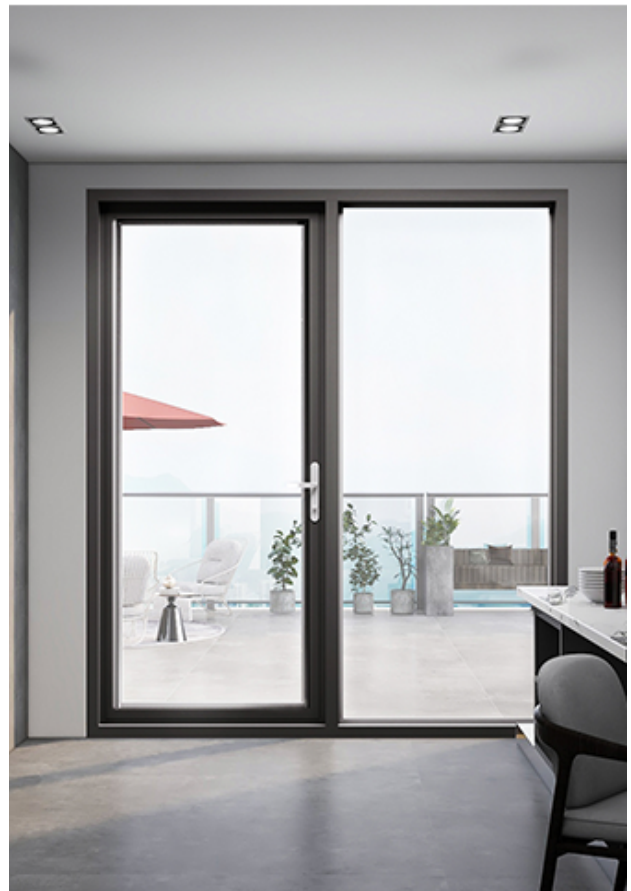



# 120

Aluminium Sutter doors





## OUTDOOR SPRING DOOR

THE INTERWEAVING OF NATURAL AND MODERN BEAUTY CREATES A PROFOUND CHARM WITHIN THE SPACE. THE DELICATE SURFACE TEXTURE ENHANCES THE ESSENCE OF NATURE, ALLOWING ITS BEAUTY TO BE FULLY EXPRESSED WHILE ADDING A UNIQUE TOUCH OF CHARACTER AND ELEGANCE TO THE ENVIRONMENT.



# PT DOOR

SWING OR SLIDE IT ADAPTS TO YOUR NEEDS!  
EXPERIENCE VERSATILITY WITH DUAL OPENING  
OPTIONS, SWING OR SLIDE, DESIGNED TO  
TRANSFORM YOUR USAGE EXPERIENCE.



# PT DOOR



DOUBLE-TRACK



TRIPLE TRACK



TRIPLE SYNCHRONIZATION



TRIPLE SYNCHRONIZATION



HINGE





## 65\*33 PT DOOR

DUAL-TRACK AND TRIPLE-TRACK  
DIAMOND MESH SCREEN

### PRODUCT PARAMETER

**Profile Wall Thickness**

1.6 mm

**HookProfile Width**

65 mm





## 33\*23 PT DOOR

DUAL-TRACK AND TRIPLE-TRACK

### PRODUCT PARAMETER

**Profile Wall Thickness**

2.0 mm

**HookProfile Width**

23 mm





## 16 PT DOOR

SINGLE GLASS PT DOOR

### PRODUCT PARAMETER

**Profile Wall Thickness**

1.2 mm

**HookProfile Width**

16 mm





## INTERIOR SLIDING DOOR

PREMIUM HANGING SLIDING DOOR,  
TWO TRACKS, TWO PANELS/TWO  
TRACKS, FOUR PANELS, THREE TRACKS,  
TRIPLE SYNCHRONIZATION

### PRODUCT PARAMETER

**Profile Wall Thickness**

3.0 mm

**Frame Width**

100/152 mm

**Opening Options**

Two-Rail Two-Panel Sliding / Two-Rail Four-Panel Sliding / Three-Rail Triple-Linked Sliding

### STANDARD CONFIGURATION

**Profile Configuration**

National Standard 6063-T5 Ultra High Precision  
Aluminum Alloy

**Thermal Barrier**

PA66 Nylon Thermal Break

**Optional Glass Types**

LOW-E / Coated / Smart / Tinted Glass

**Hardware System**

EMD Hardware

**Glass Configuration**

8mm Tempered Insulated Glass



## INTERIOR SLIDING DOOR

Design is experienced as a whole, yet its true beauty lies within the details. Every element is carefully crafted to reveal the inherent quality and refined character of the space.





## INDOOR – FLAT DOORS

FREE MATCHING,  
FANTASY COMBINATION

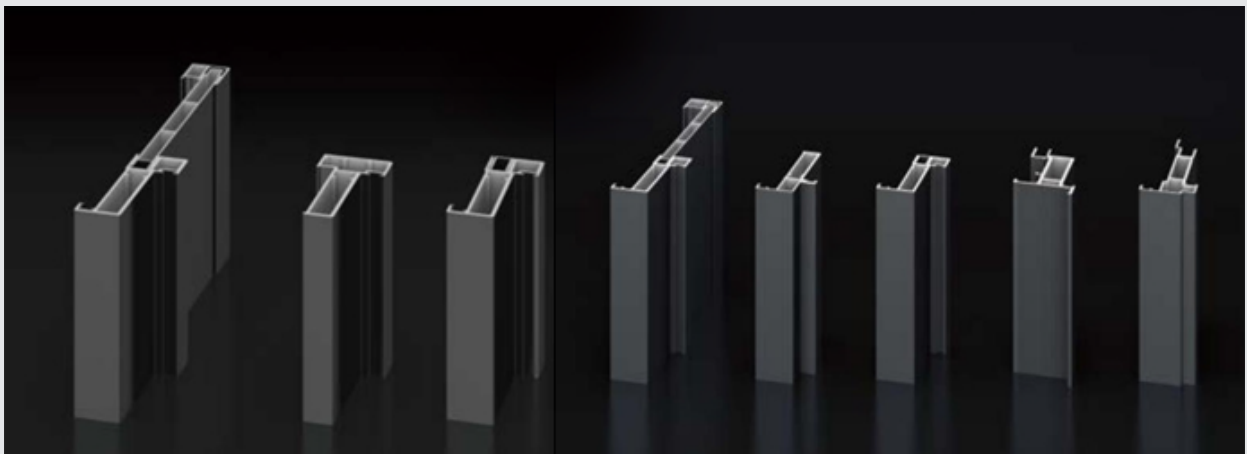



## INTERIOR PIVOT DOORS

A distinctive design language that shapes unique home atmospheres while revealing unexpected beauty. With a perfect balance of functionality and aesthetics, it features slimmer frames and a refined minimalist touch.

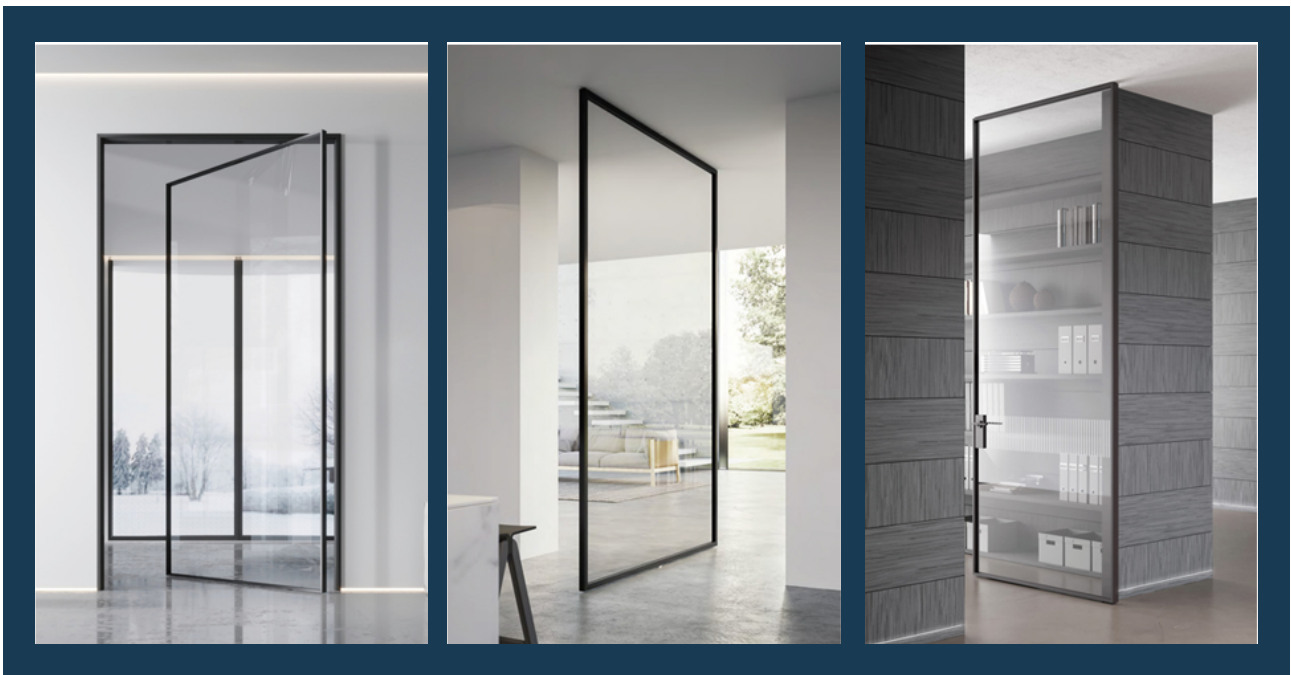



## INTERIOR FRENCH DOORS

A distinctive design language that shapes unique home atmospheres while revealing unexpected beauty. Perfectly balancing functionality and aesthetics, it features slimmer frames and refined minimalist details.



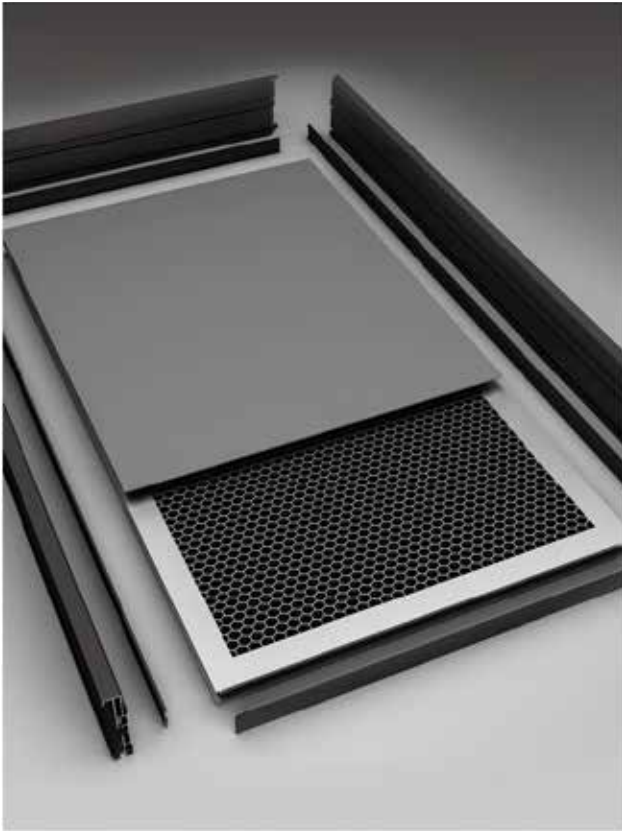

## ALUMINIUM WOOD DOOR

DOORWALL CABINET FULL CASE  
LANDING SERVICE PROVIDER



Fireproof



Insect Prevention



Eco-Friendly



Fashionable



Wearproof





# ACCESSORIES



DOOR LOCK



ATTACHMENTS



CMECH



HOPPE



## HARDWARE ACCESSORIES

G-U



SIEGENIA



KIN LONG



PANASONIC



# GLASS OPTION

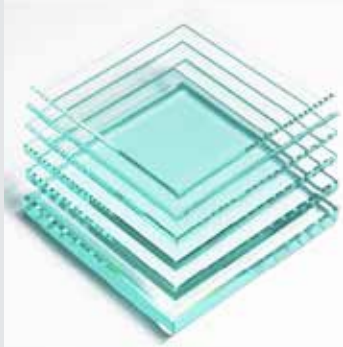

## TEMPERED GLASS

The impact strength is 3 to 5 times that of ordinary glass, and when the glass is destroyed, the fragments will become honeycomb-like small obtuse particles, which are not easy to hurt people.

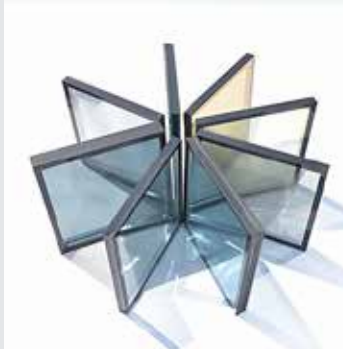

## LOW-E GLASS

Anti-ultraviolet, with heat insulation, and a heat preservation effect. According to the light transmittance, it is divided into Low, medium and high transmittance low-E.

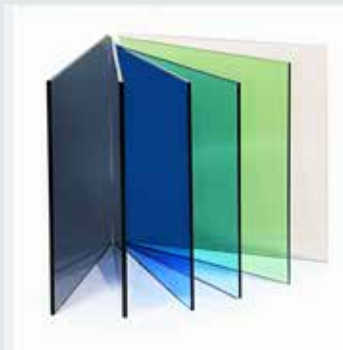

## LAMINATED GLASS

It consists of two or more pieces of glass sandwiched with one or more layers of organic polymer intermediate film. Laminated glass has good safety; even if broken will not be scattered, and can effectively prevent personnel injury. At the same time, it also has certain sound insulation and heat insulation properties



## TINTED GLASS

Colored glass is coated with metal oxides or organic matter, which can change the colour and light transmission of the glass. It can not only block UV rays, reduce the fading of indoor furniture and decorations, but also improve indoor privacy.

# GLASS OPTION

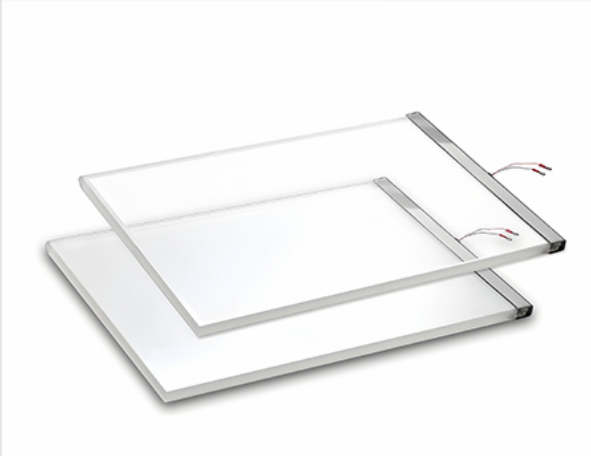

## DIMMING GLASS

Dimming glass can be controlled by electric control, temperature control, light control, pressure control and other ways to achieve the transparent and opaque state of the glass switch.



## AMBERINA

Art glass has a unique appearance and fine texture, which can significantly enhance the beauty of interior decoration and improve the privacy of the interior.



## BULLETPROOF GLASS

Bulletproof glass not only has the light transmission and image transmission performance of glass, but also has the protection ability of bulletproof glass. The bulletproof principle of bulletproof glass is that it can convert the kinetic impact energy of the bullet into the elastic potential energy of the glass and the surface energy of the fragment.

# STANDARD COLOUR CHIPS



METALLIC GREY



RUBY RED

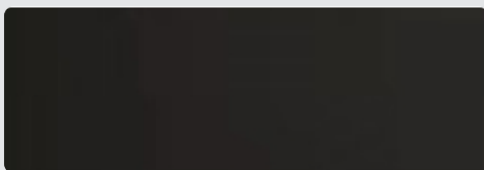

DEEP SKIN



MELANITE

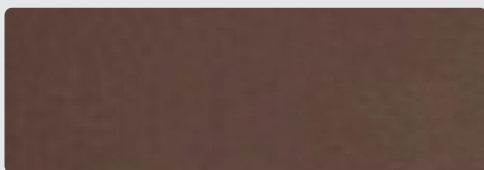

METALLIC COFFEE



MOSS GREY

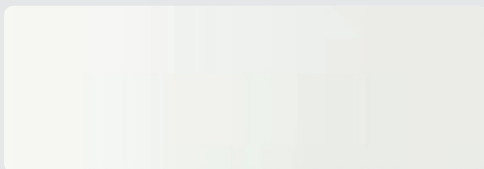

FAIR SKIN



METALLIC GREY



CHOCOLATE BROWN



LVORY



SIGNAL BROWN



PASTEL BLUE

# SCREEN

**Screen Styles:** Fixed Fly Screen, Sliding Fly Screen, Rolling Fly Screen,  
Retractable Fly Screen

**Metarials Options:** Fibreglass / 302 Stainless Steel / Aluminium



# ENGINEERING PRODUCT

(HOTEL, HOSPITALS, BUSINESS OFFICE AREAS)

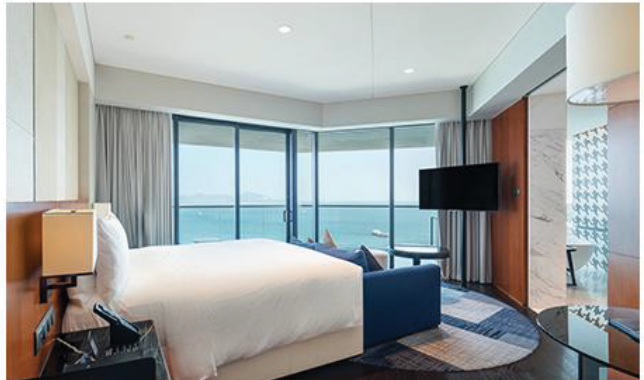



## 50 CASEMENT WINDOW

### PRODUCT PARAMETER

**Profile Wall Thickness**

1.4 mm

**Glass Configuration**

Double Glazing: 5mm+12A+5mm

Single Glazing: 5mm

**Color Chips**

Sand Grey

Sand Black

White

Coffee

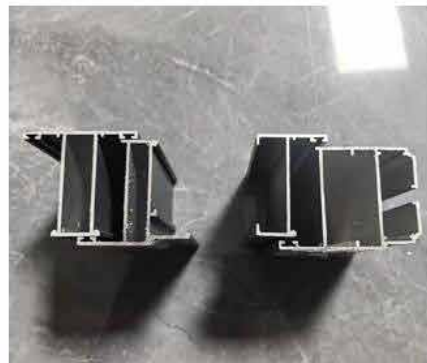
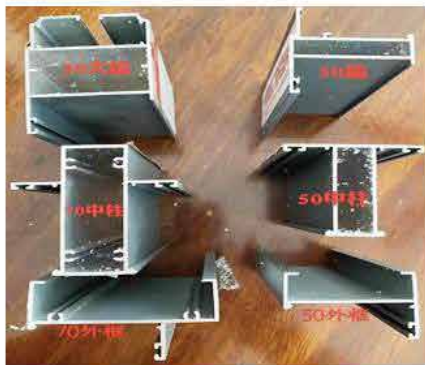



## 50 SWING DOOR

### PRODUCT PARAMETER

#### Profile Wall Thickness

1.4 mm

#### Glass Configuration

Double Glazing: 5mm+12A+5mm

Single Glazing: 5mm

#### Color Chips

Sand Grey

Sand Black

White

Coffee

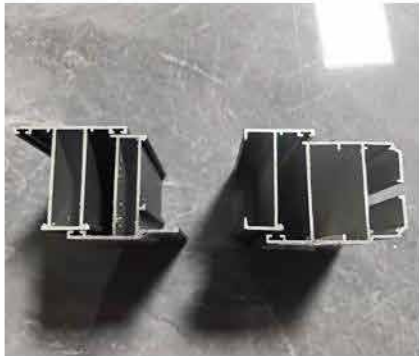



## 70 CASEMENT WINDOW

### PRODUCT PARAMETER

**Profile Wall Thickness**

1.4 mm

**Glass Configuration**

Double Glazing: 5mm+12A+5mm

Single Glazing: 5mm

**Color Chips**

Sand Grey

Sand Black

White

Coffee

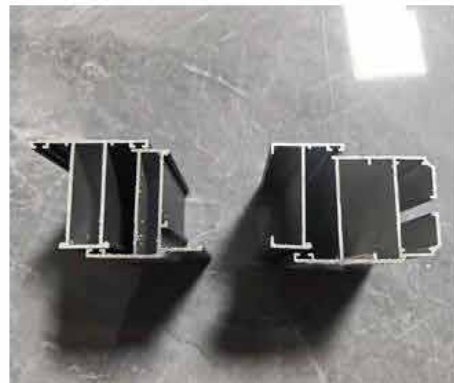
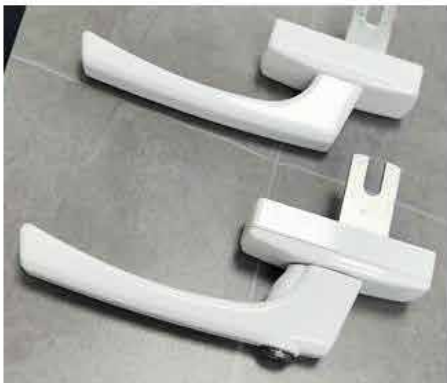
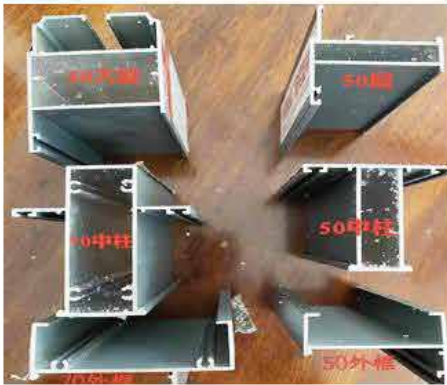



## 70 SWING DOOR

### PRODUCT PARAMETER

#### Profile Wall Thickness

1.4 mm

#### Glass Configuration

Double Glazing: 5mm+12A+5mm

Single Glazing: 5mm

#### Color Chips

Sand Grey

Sand Black

White

Coffee

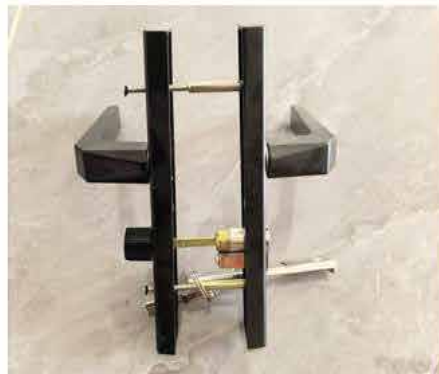
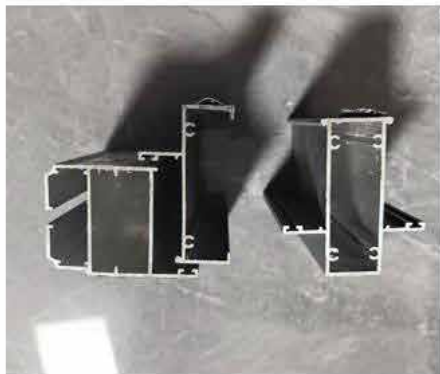



## 70 SWING ALUMINIUM LOUVERED DOOR

### PRODUCT PARAMETER

#### Profile Wall Thickness

1.4 mm

#### Glass Configuration

Double Glazing: 5mm+12A+5mm

Single Glazing: 5mm

#### Color Chips

Sand Grey

Sand Black

White

Coffee

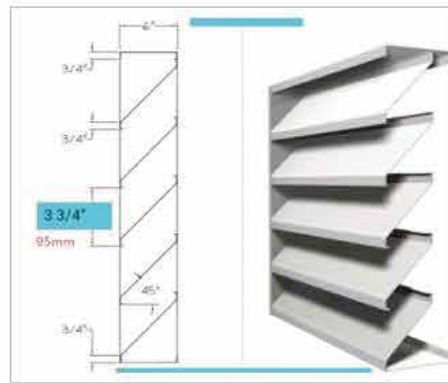
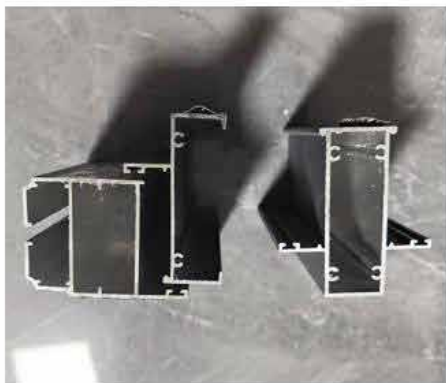



## G68 SLIDING WINDOW/DOOR

### PRODUCT PARAMETER

#### Profile Wall Thickness

1.4 mm

#### Glass Configuration

Double Glazing: 5mm+12A+5mm

Single Glazing: 5mm

#### Color Chips

Sand Grey

Sand Black

White

Coffee



# ENGINEERING PRODUCT PRO

(HOTEL, HOSPITALS, BUSINESS OFFICE AREAS)

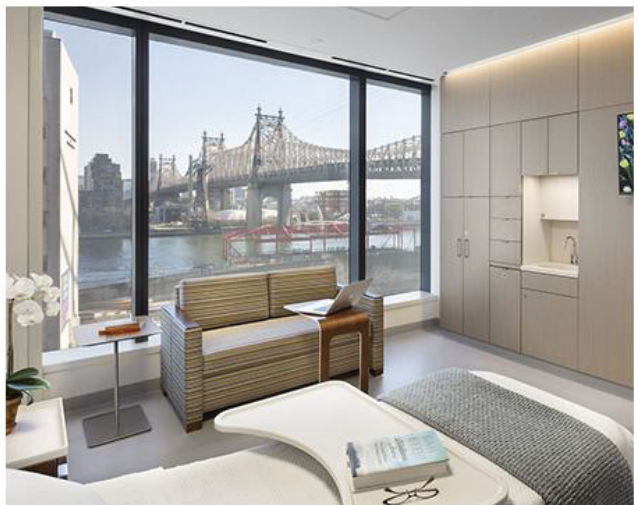
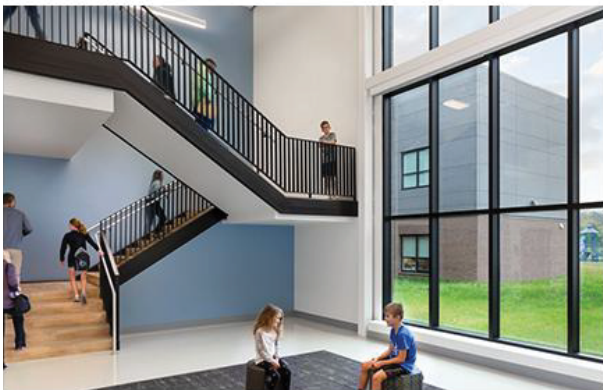



## J50 CASEMENT WINDOW/FIXED WINDOW

### PRODUCT PARAMETER

#### Profile Wall Thickness

1.4 mm

#### Glass Configuration

Double Glazing: 5mm+12A+5mm

Single Glazing: 6mm

#### Color Chips

Sand Grey

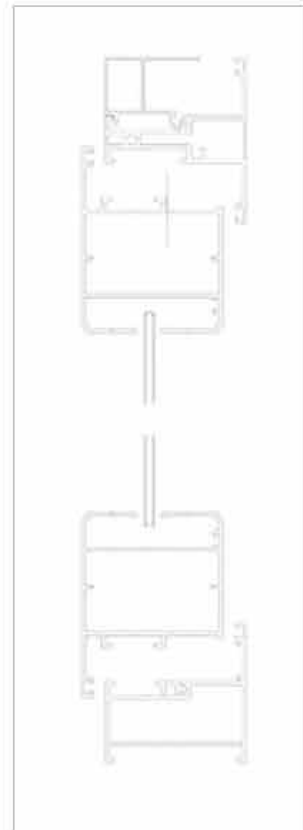



## J70 SWING DOOR

### PRODUCT PARAMETER

**Profile Wall Thickness**

1.6 mm

**Glass Configuration**

Double Glazing: 5mm+20A+5mm

Single Glazing: 6mm

**Color Chips**

Sand Grey

Sand Black

White





## 50 CASEMENT WINDOW

### PRODUCT PARAMETER

**Profile Wall Thickness**

1.4 mm

**Glass Configuration**

Double Glazing: 5mm+18A+5mm

Single Glazing: 5mm

**Color Chips**

Sand Grey

Sand Black

White

Coffee



### ADVANTAGES

The position features a transition frame, the fixed glass requires no outdoor sealant, and the direct drainage system ensures simple installation



## 55/60 THERMEL BREAK ALUMINIUM CASEMENT WINDOW

### PRODUCT PARAMETER

**Profile Wall Thickness**

2 mm

**Glass Configuration**

Double Glazing: 5mm+12A+5mm

**Color Chips**

Sand Grey

White

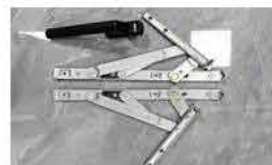

Exterior fixed glass installation without sealant application, Direct drainage system



## 77-68 TWO-TRACK SLIDING WINDOW

### PRODUCT PARAMETER

**Profile Wall Thickness**

1.4 mm

**Glass Configuration**

Double Glazing: 5mm+9A+5mm

**Color Chips**

Sand Grey

Sand Black

White

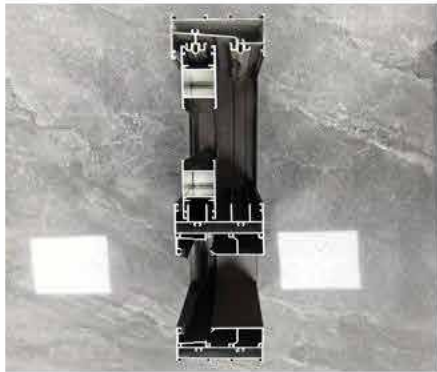



## 111-68 THREE-TRACK SLIDING WINDOW WITH SCREEN

### PRODUCT PARAMETER

#### Profile Wall Thickness

1.4mm

#### Glass Configuration

Double Glazing: 5mm+12A+5mm

Single Glazing: 5 mm

#### Color Chips

Sand Grey

Sand Black

White





## 50 SINGLE AND DOUBLE HUNG WINDOWS

### PRODUCT PARAMETER

#### Profile Wall Thickness

1.4mm

#### Glass Configuration

Double Glazing: 5mm+9A+5mm

Single Glazing: 5 mm

#### Color Chips

Sand Grey

Sand Black

White

Coffee

Champagne

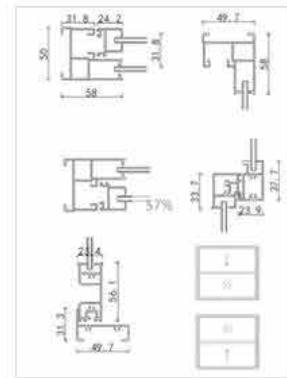
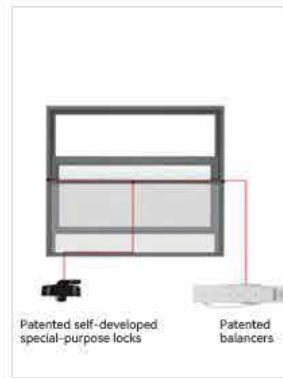



## FOLDING WINDOW

### PRODUCT PARAMETER

#### Profile Wall Thickness

1.6mm

#### Glass Configuration

Double Glazing: 5mm+20A+5mm

Single Glazing: 6mm

#### Color Chips

Sand Grey

Sand Black

White

Coffee

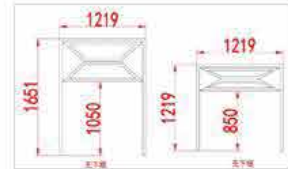
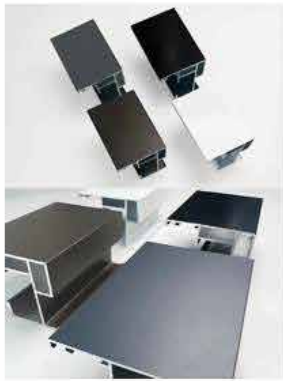



## ULTRA-NARROW GHOST DOOR

### PRODUCT PARAMETER

**Profile Wall Thickness**

2mm

**Glass Configuration**

Single Glazing: 8 mm





## 4516 FLOOR SPRING GLASS DOOR

### PRODUCT PARAMETER

#### Profile Wall Thickness

Frame 2.0, Glazing Stile 2.0

#### Glass Configuration

Double Glazing: 4mm+15A+4mm

Single Glazing: 8mm





# SKYLIGHT



**SR -R30**  
NARROW SIDE SUNROOF



Note: This product quote does not include glass



Selective Color: Colors customizable (Cost different)

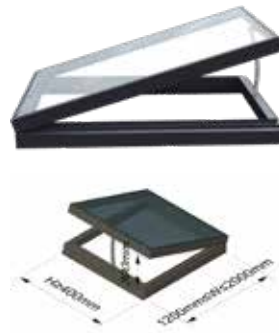

Single fan design limitation

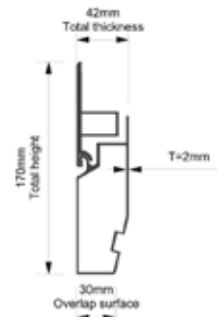

Material:  
6063-T5 Aluminium profile

**Applicable space:** Roof, lighting well, basement and sunshine room

**Open Method:** Electric upper suspension outward opening

**Process craft:** Robot seamless welding

**Surface treatment:** Whole window electrostatic powder spraying

**Glass configuration (Selective):**  
laminated glass

5mm+27Ar+5mm

5mm+0.76pvb+5mm

5mm+22Ar+5mm+0.76pvb+5mm

**Standard configuration:**

Chain Motor

Patented control system

Mute waterproof switch

LED Light

Automobile-grade sealant strip

**SR -R90**  
ELECTRIC TOP-HUNG  
SKYLIGHT



Note: This product quote does not include glass

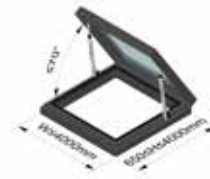

Single fan design limitation

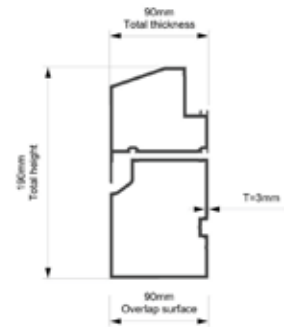

Material:  
6063-T5 Aluminium profile

**Applicable space:** Roof, lighting well, basement and sunshine room

**Open Method:** Electric upper suspension outward opening

**Process craft:** Robot seamless welding

**Surface treatment:** Whole window electrostatic powder spraying

**Glass configuration (Selective):**

**laminated glass**

5mm+27Ar+5mm

5mm+0.76pvb+5mm

5mm+22Ar+5mm+0.76pvb+5mm

**Standard configuration:**

Pushrod Motor

Patented control system

Mute waterproof switch

LED Light

Automobile-grade sealant strip



Selective Color: Colors customizable (Cost different)

# SR - S110

MEDIUM SIZED SLIDING SKYLIGHT



Note: This product quote does not include glass

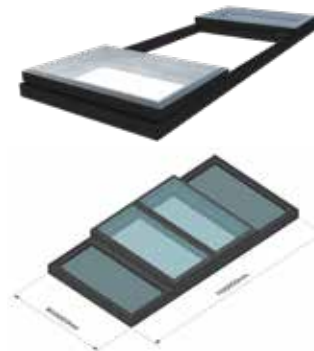

Single fan design limitation

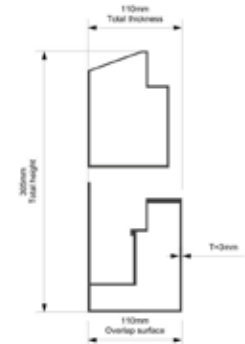

Material: 6063-T5 Aluminium profile

**Applicable space:** Basement, Patio, Daylighting well, Swimming pool, Sunshine room, Roof

**Open Method:** Electric translation

**Process craft:** Welding and glue filling corner code splicing

**Surface treatment:** Whole window electrostatic powder spraying

**Glass configuration (Selective):**

**laminated glass**

5mm+27Ar+5mm

6mm+1.52pvb+6mm

5mm+22Ar+5mm+0.76pvb+5mm

**Standard configuration:**

DC Geared Motor

Patented control system

Mute waterproof switc

304 stainless steel solid bearing pulley

Solid steel reinforced corner code

45# solid gear rack (anti-corrosion treatment)

Automobile grade sealant strip

304 stainless steel track

Anti falling device



Selective Color: Colors customizable (Cost different)

**SR - S85**  
TRACKLESS SMALL PAN SKYLIGHT



Note: This product quote does not include glass

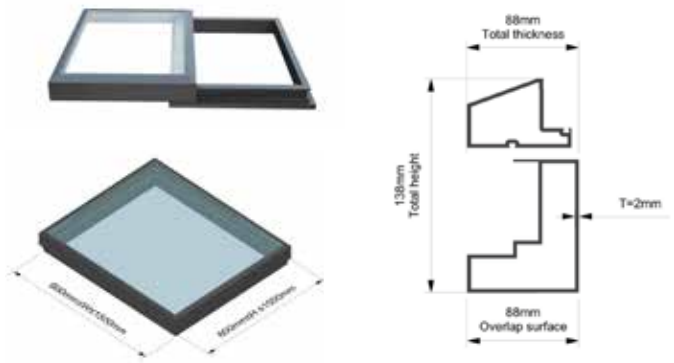

Single fan design limitation

Material:  
6063-T5 Aluminium profile

**Applicable space:** Roof, Lightwells, Basement and Sunrooms

**Open Method:** Electric translation

**Process craft:** Robot seamless welding

**Surface treatment:** Electrostatic powder spraying

**Glass configuration (Selective):**  
laminated glass

5mm+27Ar+5mm

6mm+1.52pvb+6mm

5mm+22Ar+5mm+0.76pvb+5mm

**Standard configuration:**

Tubular Motor

Patented control system

Mute waterproof switch

Automobile-grade sealant strip



Selective Color: Colors customizable (Cost different)

**SR - S85**  
RAILED SMALL PAN  
SKYLIGHT



Note: This product quote does not include glass

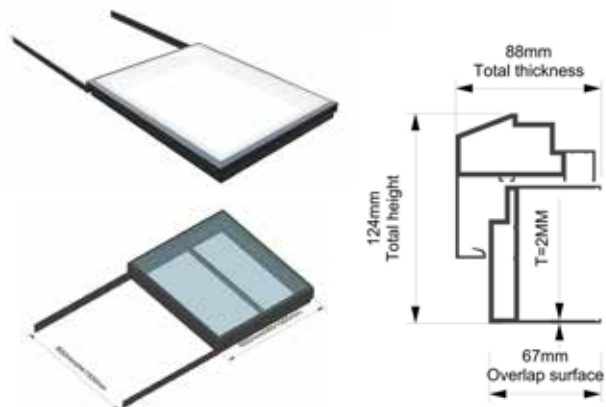

Single fan design limitation

Material:  
6063-T5 Aluminium profile

**Applicable space:** Roof, Lighting well, Sunlight room

**Open Method:** Electric translation

**Process craft:** Robot seamless welding

**Surface treatment:** Electrostatic powder spraying

**Glass configuration (Selective):**  
laminated glass

5mm+27Ar+5mm

5mm+0.76pvb+5mm

5mm+9Ar+5mm+0.76pvb+5mm

**Standard configuration:**

Tubular Motor

Patented control system

Mute waterproof switch

Automobile-grade sealant strip



Selective Color: Colors customizable (Cost different)

**SR -128**  
ELECTRIC RISING  
SKYLIGHT



Note: This product quote does not include glass

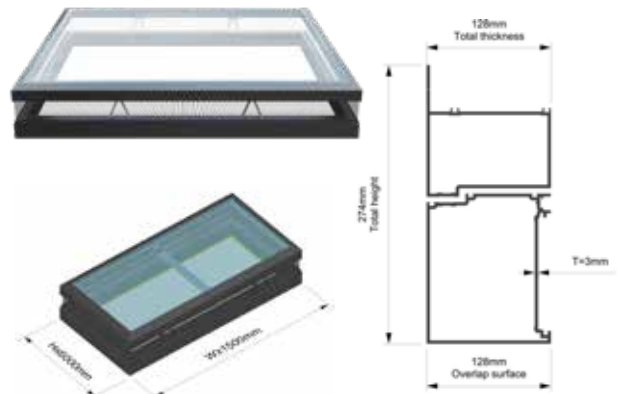

Single fan design limitation

Material:  
6063-T5 Aluminium profile

**Applicable space:** Flat roof, Daylighting well, Basement, Patio and Sunshine room

**Open Method:** Electric level rise

**Process craft:** Robot seamless welding

**Surface treatment:** Whole window electrostatic powder spraying

**Glass configuration (Selective):**  
**laminated glass**

5mm+27Ar+5mm

6mm+1.52pvb+6mm

5mm+22Ar+5mm+0.76pvb+5mm

**Standard configuration:**

DC Geared Motor

Patented control system

Mute waterproof switch

LED light

Automobile-grade sealant strip

Ring diamond gauze net



Selective Color: Colors customizable (Cost different)

# SR - R70

ALUMINIUM ALLOY ROW SKYLIGHT

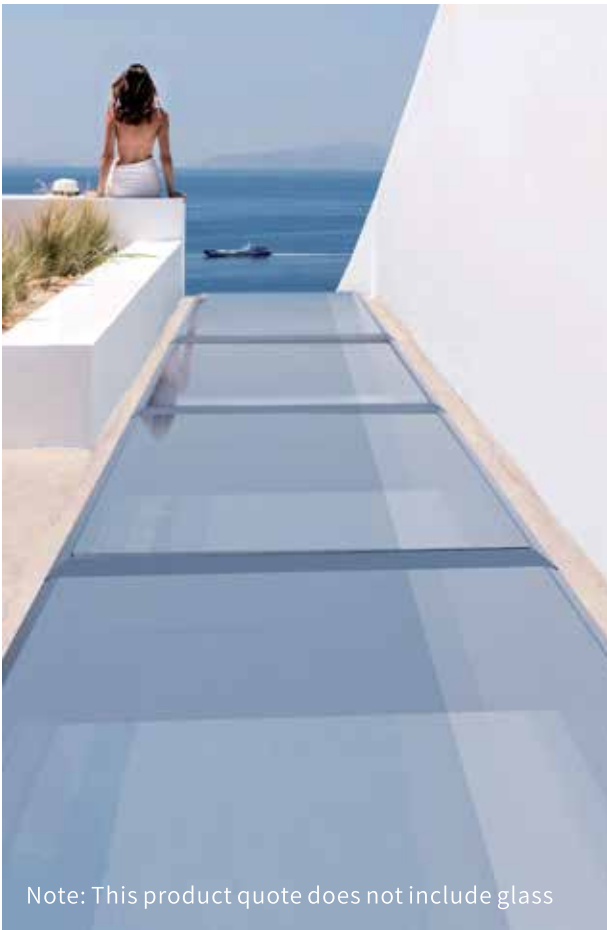

Note: This product quote does not include glass

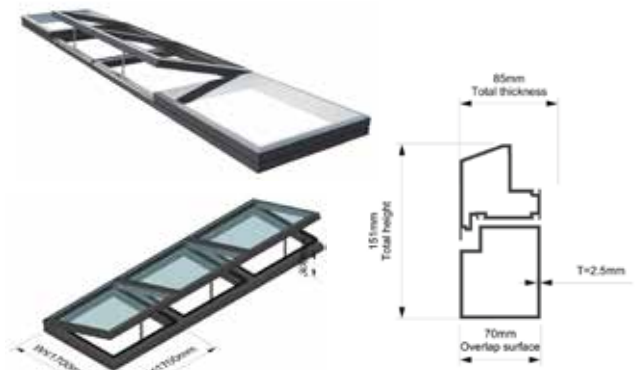

Single fan design limitation

Material:  
6063-T5 Aluminium profile

**Applicable space:** Roof, Daylight well, Basement

**Open Method:** Electric upper suspension outward opening

**Process craft:** Robot seamless welding

**Surface treatment:** Whole window electrostatic powder spraying

**Glass configuration (Selective):**

**laminated glass**

5mm+27Ar+5mm

6mm+0.76pvb+6mm

5mm+22A+5mm+0.76pvb+5mm

**Standard configuration:**

Chain Motor

Patented control system

Mute waterproof switch

LED light

Automobile-grade sealant strip



Selective Color: Colors customizable (Cost different)

# SR -R85

INSULATED ALUMINIUM SKYLIGHT



Note: This product quote does not include glass

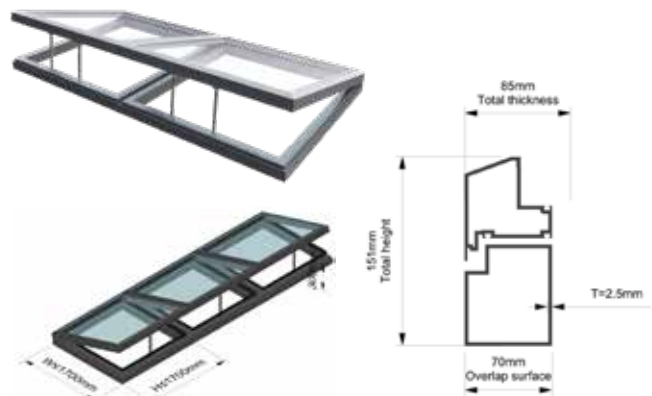

Single fan design limitation

Material:  
6063-T5 Aluminium profile

**Applicable space:** Roof, Daylight well, Basement

**Open Method:** Electric upper suspension outward opening

**Process craft:** Robot seamless welding

**Surface treatment:** Whole window electrostatic powder spraying

**Glass configuration (Selective):**

**laminated glass**

5mm+27Ar+5mm

6mm+0.76pvb+6mm

5mm+22A+5mm+0.76pvb+5mm

**Standard configuration:**

Chain Motor

Patented control system

Mute waterproof switch

Automobile-grade sealant strip

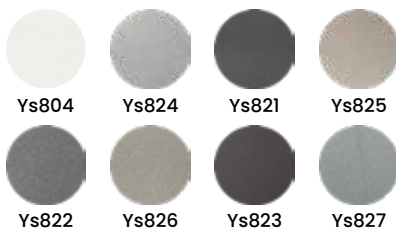

Selective Color: Colors customizable (Cost different)

# SR -R20

ELECTRIC SUNROOF FOR  
GLASS ROOM



Note: This product quote does not include glass

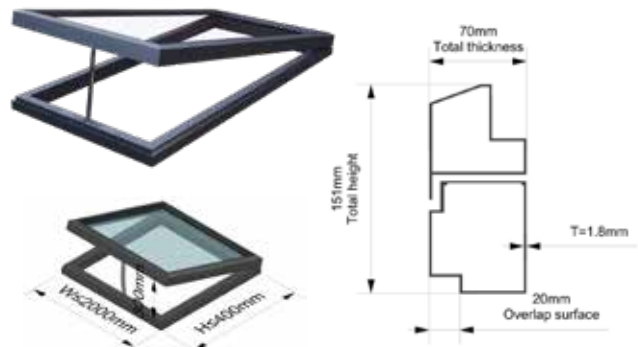

Single fan design limitation

Material:  
6063-T5 Aluminium profile

**Applicable space:** Roof, Lighting well, Sunlight room

**Open Method:** Electric upper suspension outward opening

**Process craft:** Robot seamless welding

**Surface treatment:** Whole window electrostatic powder spraying

**Glass configuration (Selective):**

**laminated glass**

5mm+27Ar+5mm

6mm+0.76pvb+6mm

5mm+22A+5mm+0.76pvb+5mm

**Standard configuration:**

Chain Motor

Patented control system

Mute waterproof switch

Automobile-grade sealant strip



Selective Color: Colors customizable (Cost different)

**SR – S110S**  
**AUTOMATIC RETRACTABLE**  
**GLASS ROOM**



Note: This product quote does not include glass

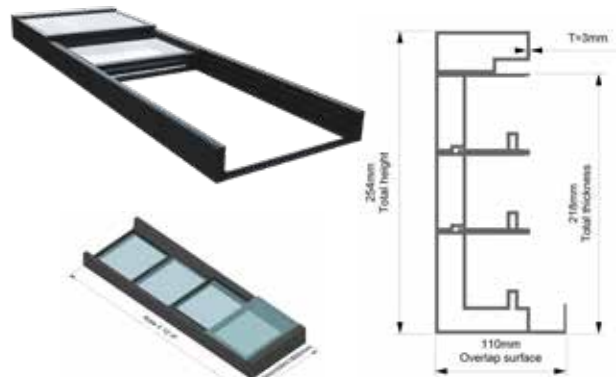

Single fan design limitation

Material:  
 6063-T5 Aluminium profile

**Applicable space:** Roof, Lighting well, Basement, Stairwell and Sunshine room

**Open Method:** Electric translation

**Process craft:** Robot seamless welding

**Surface treatment:** Whole window electrostatic powder spraying

**Glass configuration (Selective):**  
**laminated glass**

5mm+0.76pvb+5mm  
 6mm+0.76pvb+6mm

**Standard configuration:**

DC Geared Motor  
 Patented control system  
 Mute waterproof switch  
 Automobile-grade sealant strip



Selective Color: Colors customizable (Cost different)

**SR - S180**  
MOBILE SUNROOM



Note: This product quote does not include glass

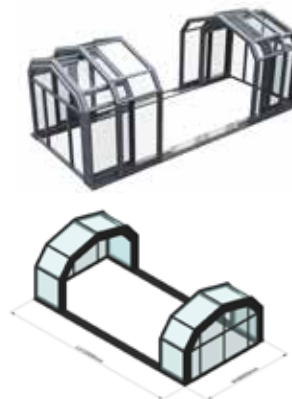

Single fan design limitation

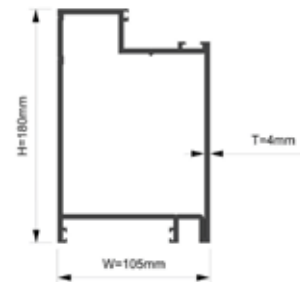

Material:  
6063-T5 Aluminium profile

**Applicable space:** Swimming pool, Spa pool, Rooftop, Restaurant, Cafe, Lounge Space

**Open Method:** Electric Translation

**Surface treatment:** Whole window electrostatic powder spraying

**Glass configuration (Selective):**

**laminated glass**

5mm+27Ar+5mm

6mm+0.76pvb+6mm

5mm+22Ar+5mm+0.76pvb+5mm

**Standard configuration:**

Worm gear motor

Wireless solar rain sensor

Wireless remote

LED light

Mobile Remote Control



Selective Color: Colors customizable (Cost different)



# INTERIOR DOOR

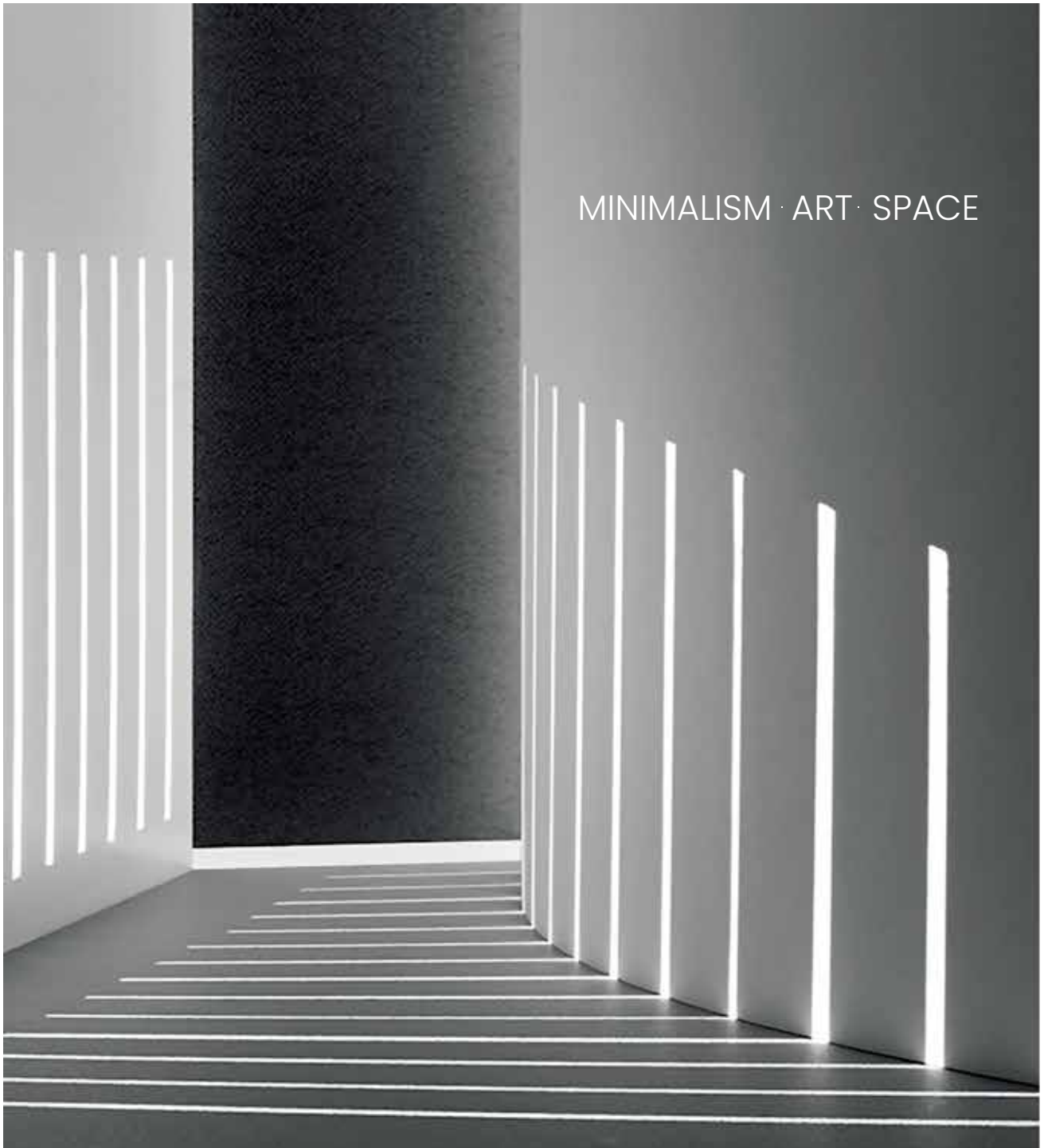



## EXPLORE THE BEAUTY OF LIFE

Open every door of life in the purest way

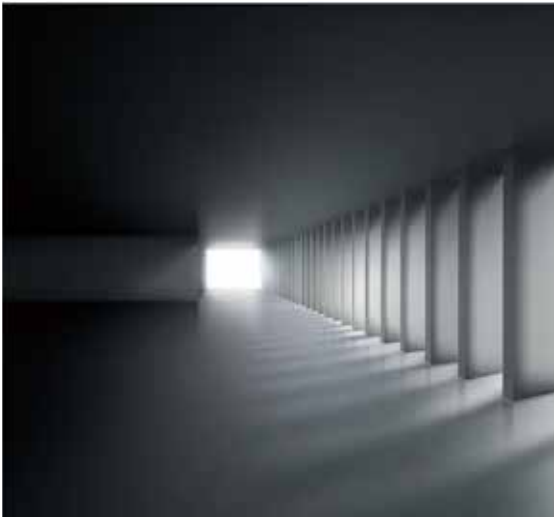

## Minimalist home customisation makes your home more loving

The minimalist door, with its exquisite texture, exudes urban luxury and fashion. Its classic and stylish design, along with years of exquisite craftsmanship and refined taste, allows the door to resonate with the aura of the person wearing it. It transforms the door from a mere door into a work of art for living.

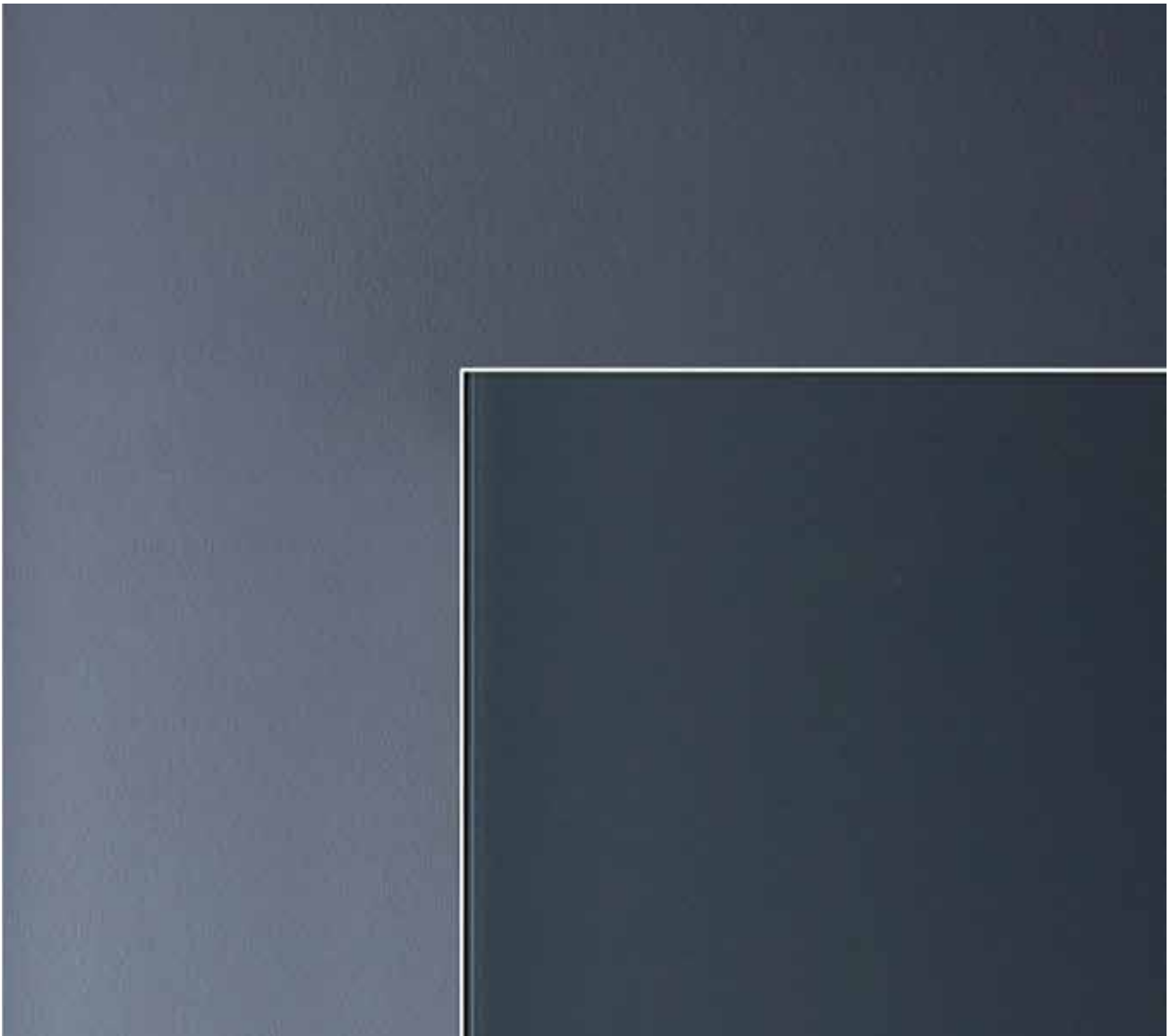

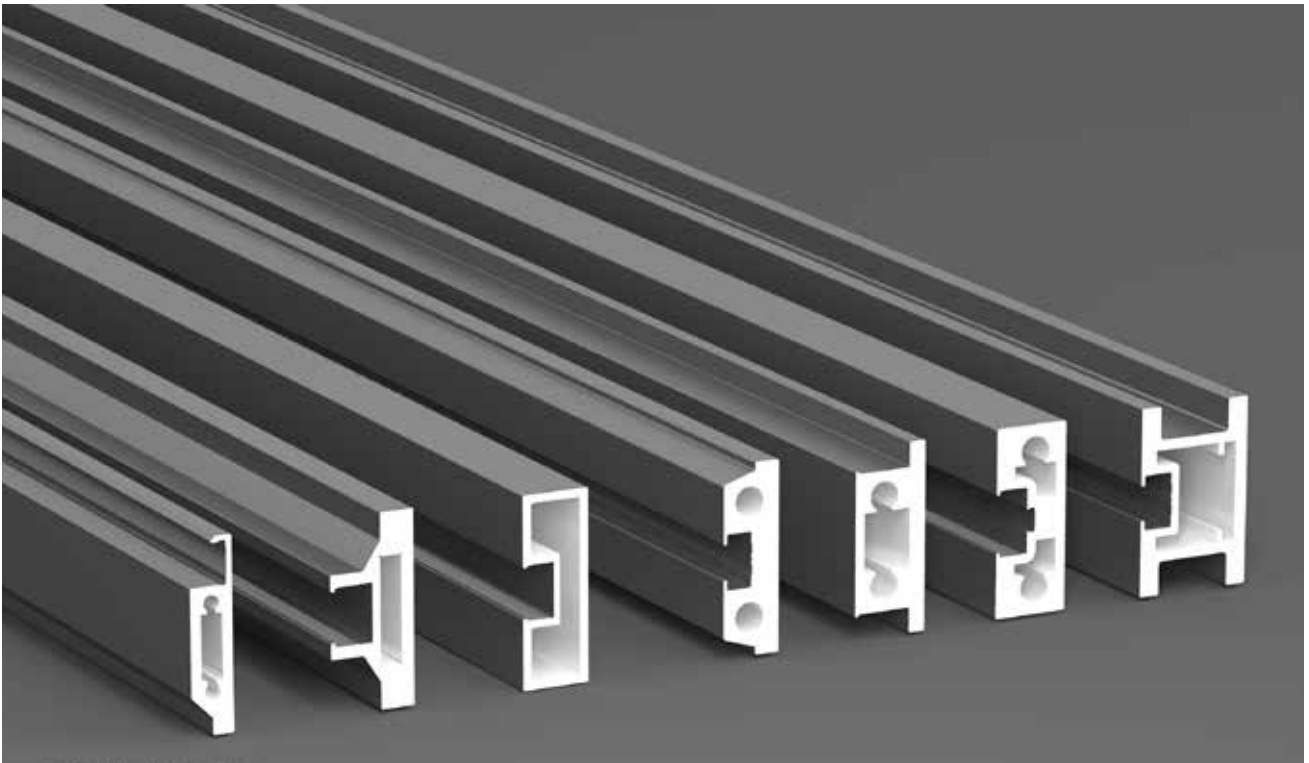

## OPTIONAL OPTICAL ENTERPRISES





## HANGING SLIDING DOOR

### DESIGN OF MINIMALIST SPACE

Special design style to create different home atmospheres and discover unexpected beauty. Both function and beauty are emphasised, with a narrower border, a more minimalist appearance, and a delicate touch.



## HANGING SLIDING DOOR



Monorail sliding door



Double-track sliding door



Triple linkage sliding door

## ULTRA NARROW SLEEVE

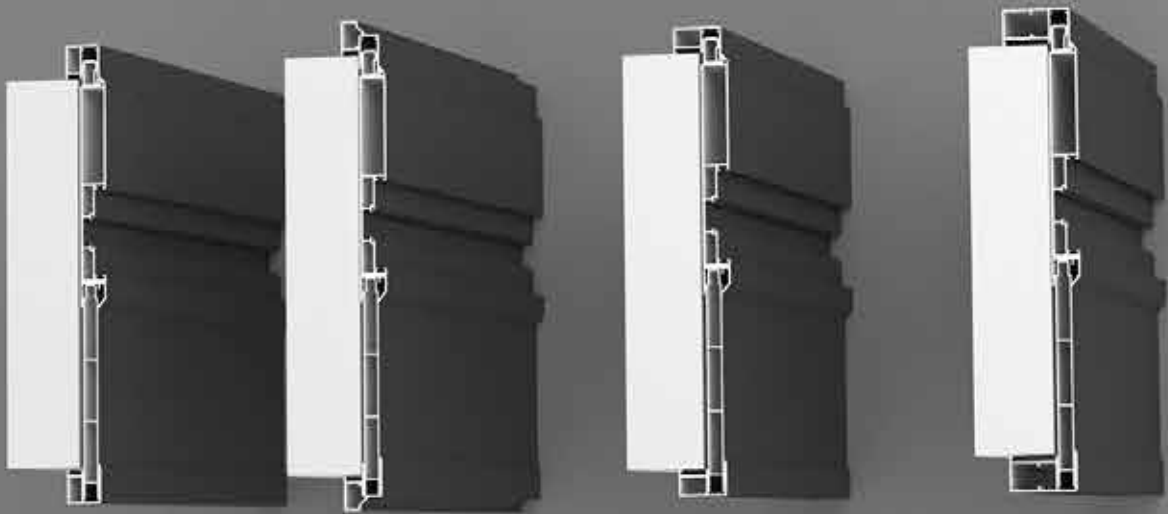

8mm



11mm



15mm



26mm

## THE MINIMALIST LIGHT OF LUXURY STATE

Its minimalist visual appeal, time-saving, convenient, and practical features are harmoniously combined, making it both irresistible and utterly captivating.



Special design style to create different home atmospheres and discover unexpected beauty. Both function and beauty are emphasised, with narrower borders and a more minimalist and delicate touch

Build a high taste of life, the pursuit of fashion and contracted, remove the multifarious and impetuous, return to naturalness, a high-quality leisure life, life for the perfect deduce.





The glass door wall partition eliminates the boundary between the door panels and frames, making them perfectly coplanar with the wall. Various exquisite designs simplify the spatial structure while retaining the overall sense and fluidity of the space.



Customize according to personal preferences, do whatever you want, beyond your imagination.



Not limited to limited space, when a sense of structure intervenes light and shadow add depth to the space

Design is seen in whole, fully hidden in details, exploring the details with care, and touching the inherent quality



## OPTIONAL TRACK SYTEM



Monorail Shock Absorbing Track  
Track dimensions: 47.8\*87.8

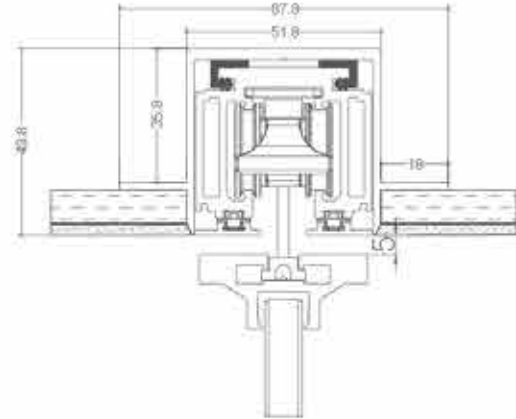

Double rail shock-absorbing track  
Track dimensions: 47.8\*144.8

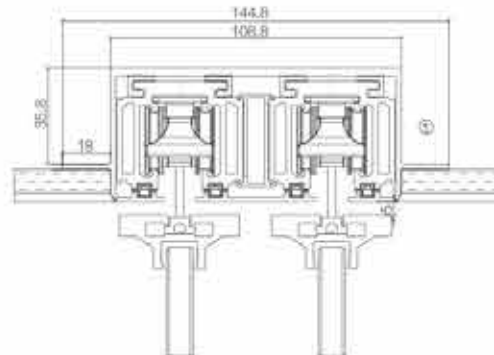

Three-rail shock-absorbing track  
Track dimensions: 66\*187.8

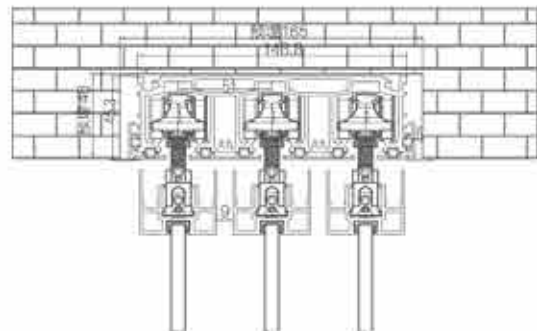

## OPTIONAL TRACK SYTEM



Monorail hanging rail  
Track dimensions: 78\*58

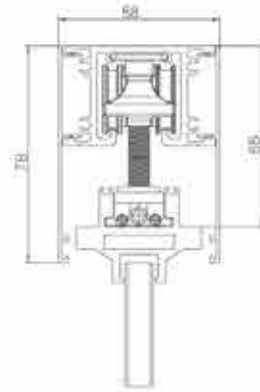

Double rail hanging rail  
Track dimensions: 78\*115

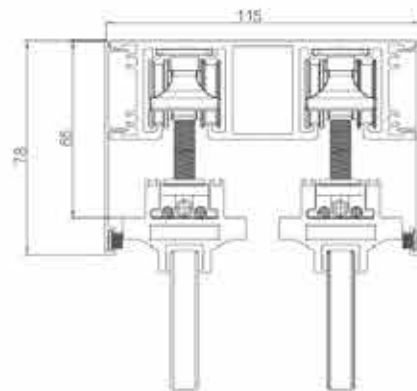

Three-rail hanging rail  
Track dimension: 78\*172

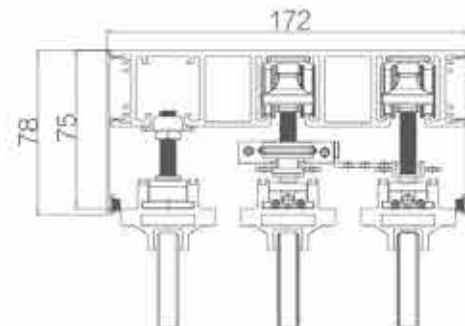

## OPTIONAL TRACK SYTEM



Monorail push-pull track  
Track dimensions: 47.8\*87.8

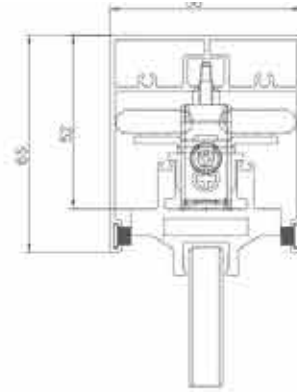

Double-track push-pull track  
Track dimensions: 47.8\*144.8

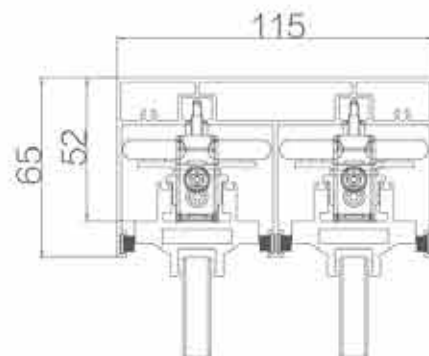

Three-track sliding track  
Track dimensions: 66\*187.8

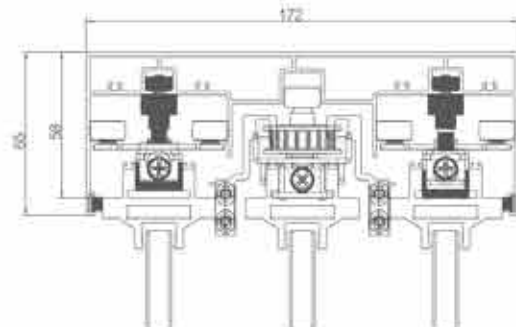

## LINEAR STEEL WIRE SUSPENSION RAIL

---

- High performance
- High quality
- Attractive design



025 / 026

# FLAT DOOR SERIES



Italian-style cloud mirror double-walled hinged door assembly diagram



Italian-style Yunde single-package hinged door assembly diagram

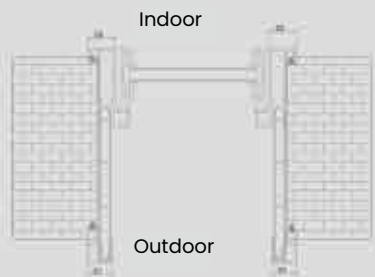
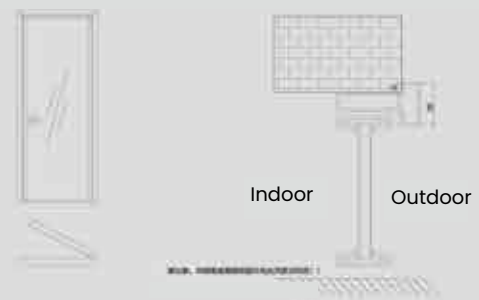

Ultra-narrow flat double pack

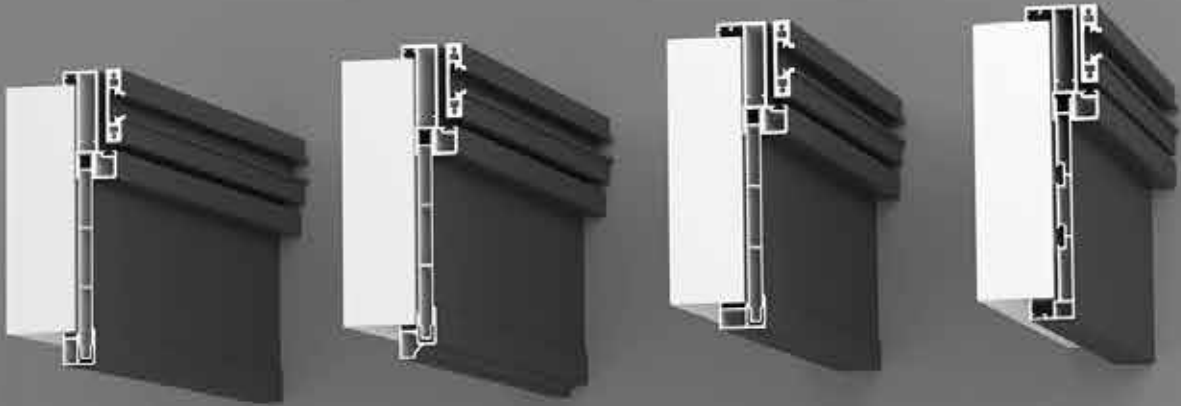

Optional Optical Enterprises

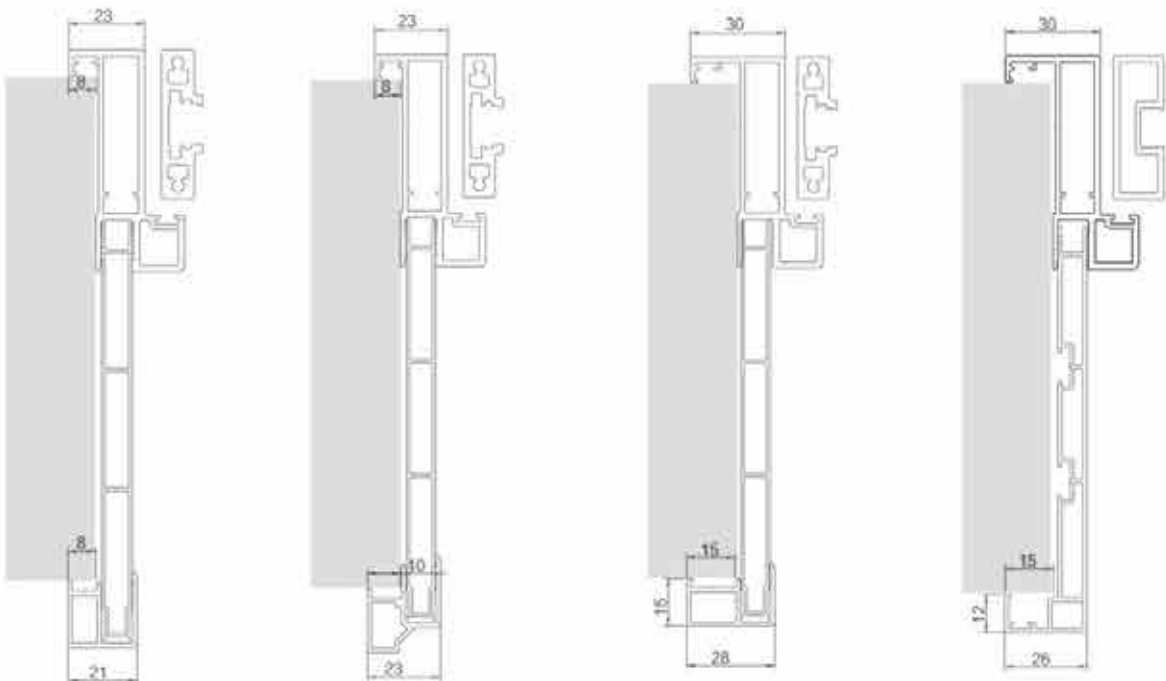

Not limited to a limited space, when a sense of structure intervenes, light and shadow add depth to the space







# HANGING DOOR SERIES

# HANGING DOOR SERIES

Monorail Shock Absorbing Track

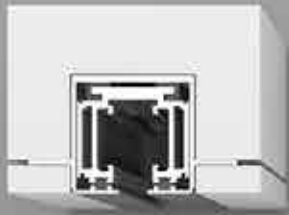

Double rail shock-absorbing track



Monorail Hidden Track



Double track hidden track



TL16



TLX4



TL18



TL28



Pocket doors can effectively solve the partition problem of short front and rear distances and small door openings, hiding everything in between

Every door is a loyal listener of the story. The noble and elegant tone is the percipitation of years. It is rich and delicate.





Design is seen in the whole, fully hidden in the details, exploring the details with care, and touching the inherent quality





Traditional Japanese style building a reasonable sense of order for minimalism with simple yet extraordinary details creating every bit of BEAUTY OF LIFE

Cultivating a refined taste for life, it pursues modern style and simplicity—eliminating unnecessary complexity to create a natural, high-quality, and leisurely living experience.





In modern life, we are constantly surrounded by noise and endless distractions. Only a few truly pause to experience the calm, imagination, and relaxation that minimalist living offers.

Where elegance meets innovation—the hidden track suspension door appears to float effortlessly, bringing smooth movement, refined design, and creative charm to modern spaces.



# ITALIAN LIGHT AND SHADOW SERIES



Italian-style  
singlet-track lighting



Italian-style  
dual-track lighting



Italian-style  
three-track lighting





An extraordinary expression of innovation and sophistication, the Ezzodors Italian Light & Shadow System Sliding Door harmoniously integrates advanced technology with refined aesthetics. Designed for diverse spatial applications, it creates seamless transitions between spaces, redefining the concept of modern partitions. Light, elegant, and fluid in movement, it delivers a graceful balance between design, functionality, and architectural beauty.





Simple hollow partitions and classic grille design bring timeless and shadowy tables. The light and shadow effect is luxurious with a hint of mystery





Within every heart exists a rich and complex emotional world. The Ezzodoors Retro Sliding Door Series is inspired by collage art—seamlessly bringing together light, space, and emotion to transform your home into a place where life's moments beautifully intersect.



## ITALIAN LIGHT AND SHADOW SERIES

The Ezzodoors Italian Light & Shadow System represents five generations of innovation, combining ultra-slim frame design with refined Italian craftsmanship. Every detail is engineered to deliver world-class performance and modern elegance.

Built with advanced technology and precision manufacturing, it offers excellent durability, resistance to moisture and corrosion, fade protection, and effective sound insulation.

Designed for versatile applications, the system integrates seamlessly into spaces such as living rooms, study rooms, and balconies. Elegant, flexible, and functional, it redefines modern spatial design while enhancing both interior and exterior environments.

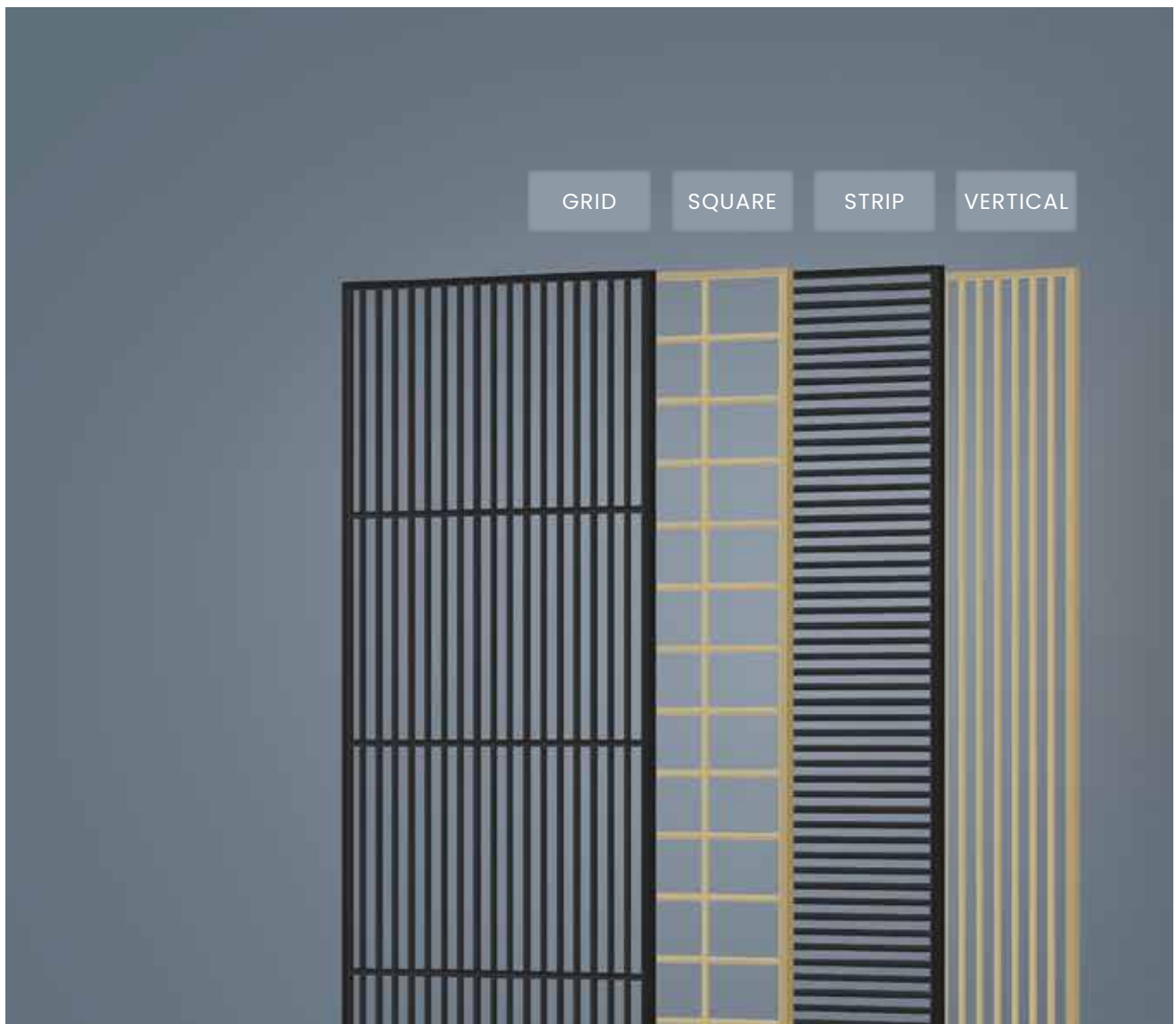



Build a high taste of life, the pursuit of fashion and contracted, remove the multifarious and impetuous, return to naturalness, a high-quality leisure life, life for the perfect deduce.

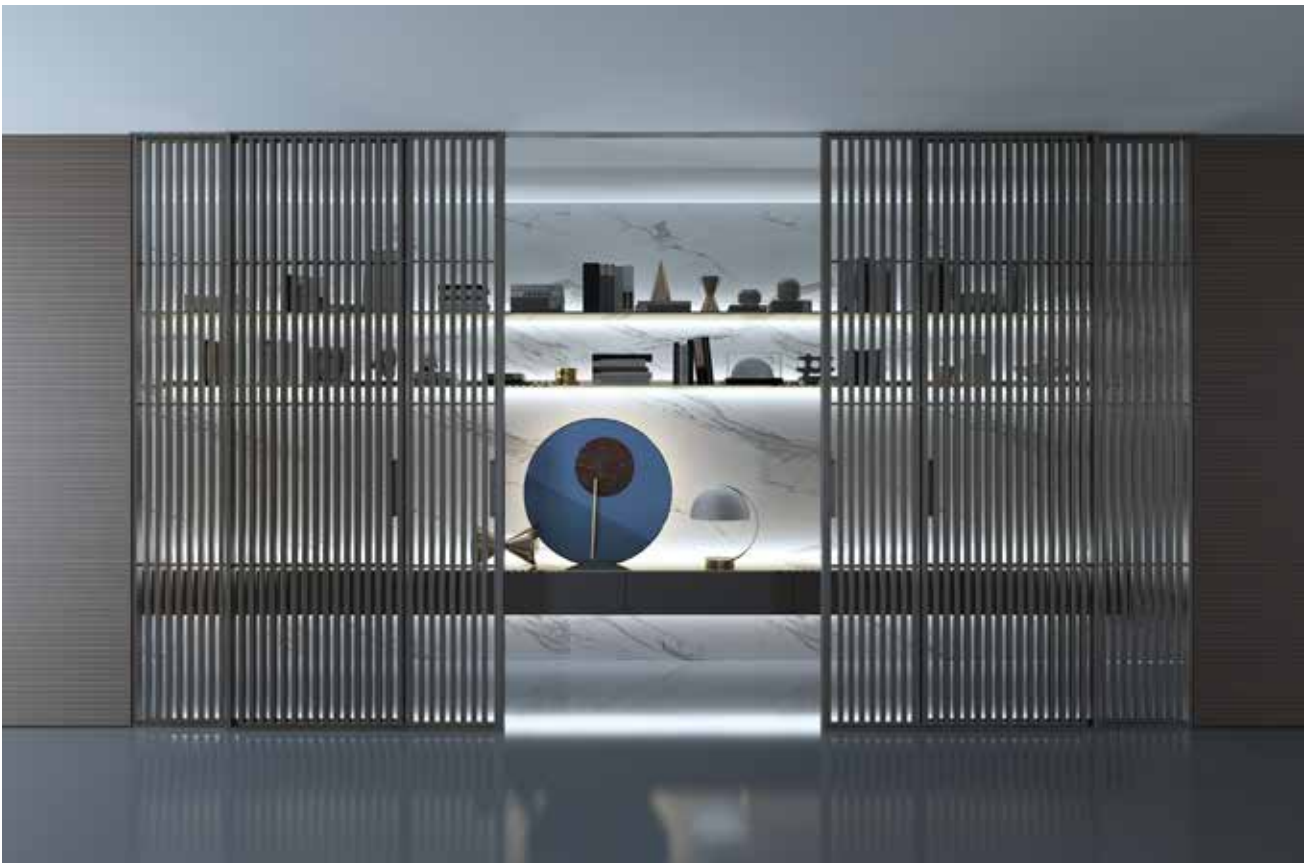

# ITALIAN STYLE LIGHT AND SHADOW SWING DOOR SERIES



Italian-style light and shadow open



Italian-style light and shadow double-sided flat opening



Italian-style light and shadow double-sided flat opening

Italian-style double-sided swing door assembly diagram

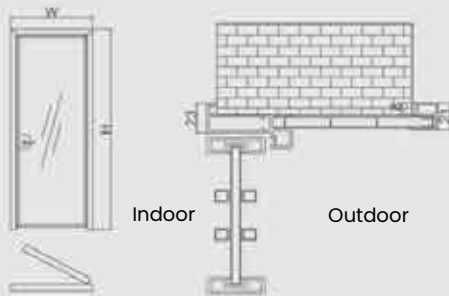

Please note: The height of the mounting legs needs to be determined based on the style of the hinges!

Italian-style light and shadow single-pack hinged door assembly diagram

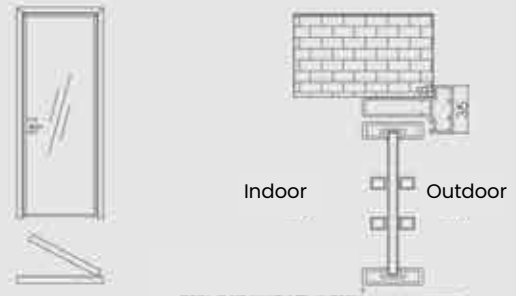

Please note: The height of the mounting legs needs to be determined based on the style of the hinges!

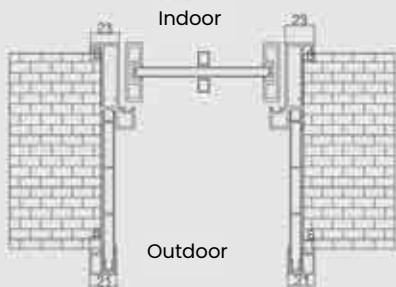



Not limited to limited space, when a sense of structure intervenes, light and shadow add depth to the space



## ITALIAN GRID DOOR SYSTEM



Italian-style  
single-track lighting



Italian-style  
dual-track lighting



Italian-style  
three-track lighting





Special design style to create different home atmospheres and discover unexpected beauty. Both function and beauty are emphasised, with narrower borders and a more minimalist and delicate touch.

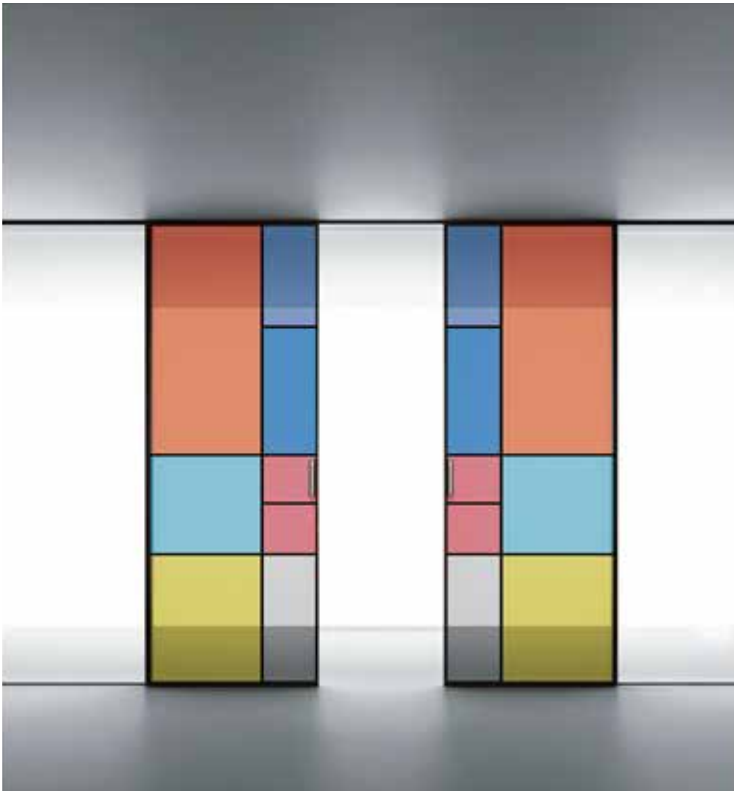

It is more than a choice of design—it is a reflection of a lifestyle and a state of mind. An expression of aesthetics and a quiet dialogue between people and space. A gentle presence in the living room, bringing comfort to the soul and harmony to the home. It is a graceful balance of beauty and calm, where elegance meets inner peace.



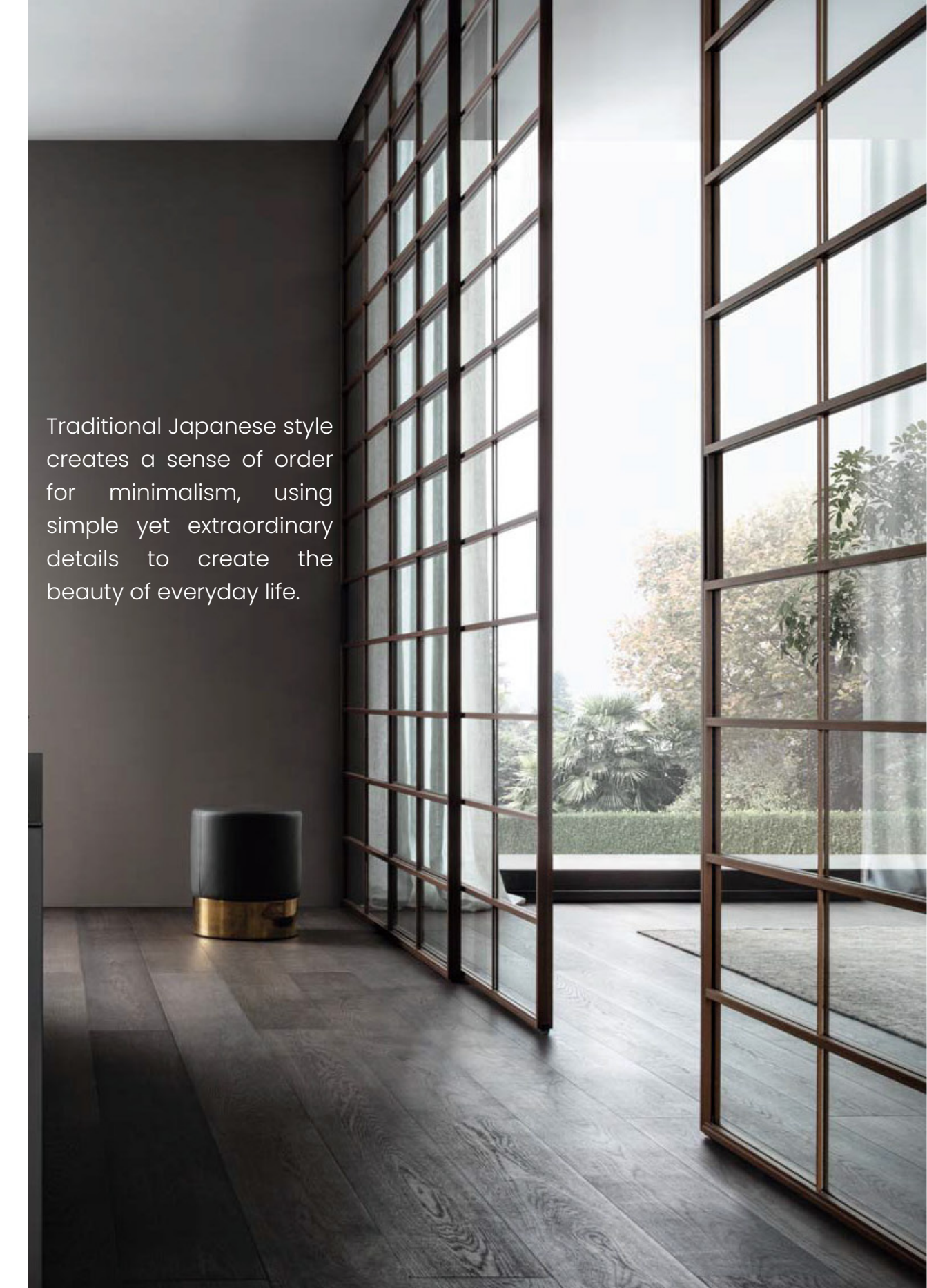

Traditional Japanese style creates a sense of order for minimalism, using simple yet extraordinary details to create the beauty of everyday life.

## PARTIAL GRID STYLE



JZ-01

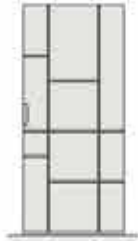

JZ-02



JZ-03



JZ-04

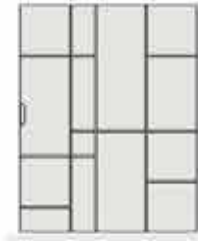

JZ-05



JZ-06



JZ-07



JZ-08



JZ-09

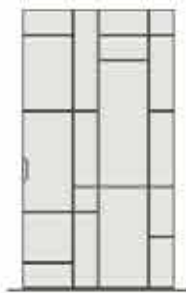

JZ-10

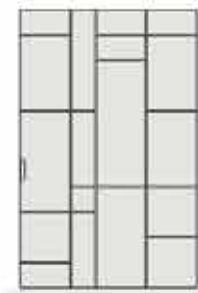

JZ-11



JZ-12



JZ-13

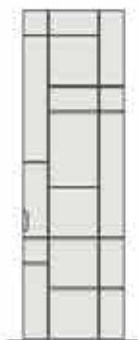

JZ-14



JZ-15

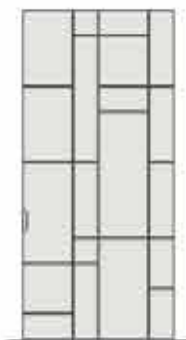

JZ-16



JZ-17



JZ-18

# ITALIAN STYLE MODULAR SWING DOOR SERIES



Italian-style light and shadow open



Italian-style light and shadow double-sided flat opening



Italian-style light and shadow double-sided flat opening

Italian-style patchwork double-sided hinged door assembly diagram

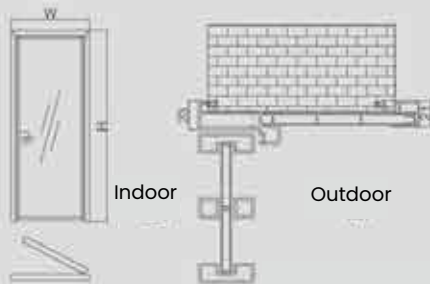

Please note: The height of the mounting legs needs to be determined based on the style of the hinges!

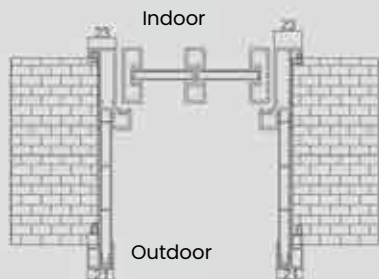

Italian-style patchwork single-pack hinged door assembly diagram

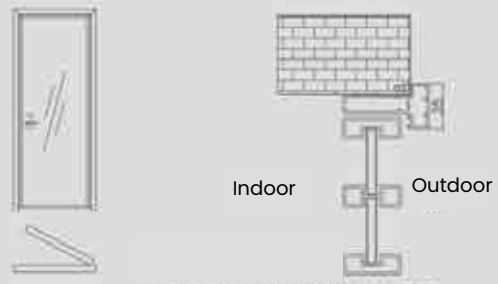

Please note: The height of the mounting legs needs to be determined based on the style of the hinges!



Traditional Japanese style creates a sense of order for minimalism, using simple yet extraordinary details to create the beauty of every day life.

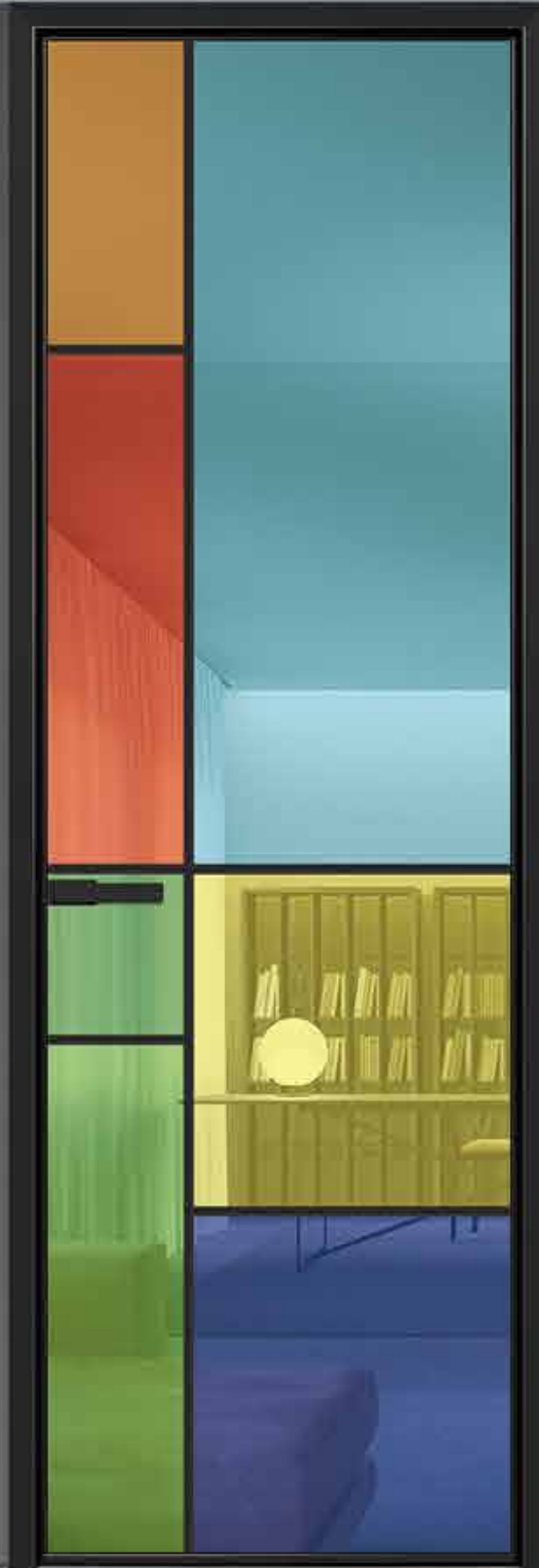



Every door is a loyal listener of the story; The noble and elegant tone is the precipitation of years. It is rich and delicate. In the face of such a home every time, it is stable and indifferent, and the secular disputes melt in an instant.

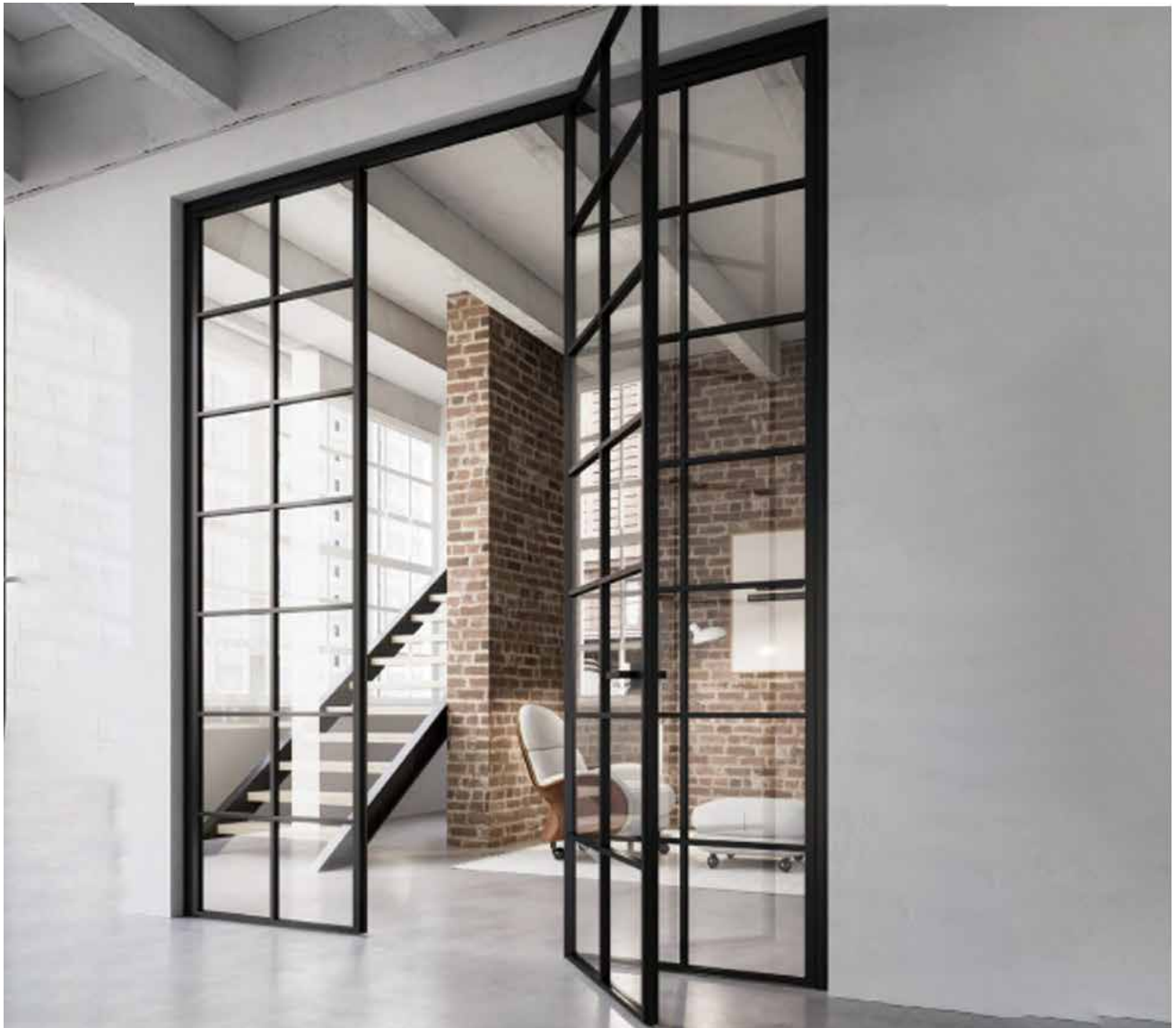

# FRENCH VINTAGE DOOR SERIES



French retro monorail



French retro double track



French retro three-track





*Traditional retro style Building a reasonable sense of order for minimalism, with simple yet extraordinary details, Creating Every Bit of Beauty in Life.*



# FRENCH RETRO SWING DOOR SERIES



French retro style flat bag



French retro style, white reverse wrapping, flat opening



French retro style double-sided open

French retro double-door swing door assembly diagram

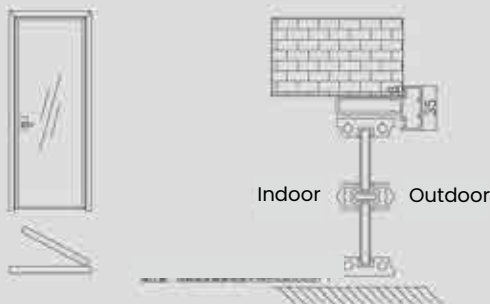

French retro single-door bag assembly diagram

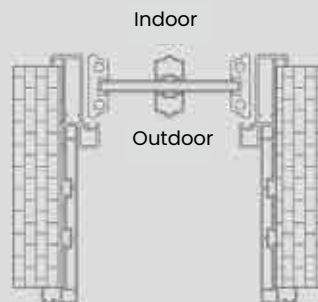
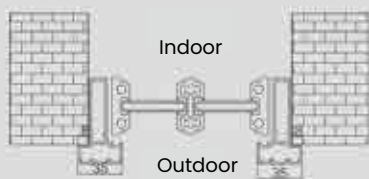
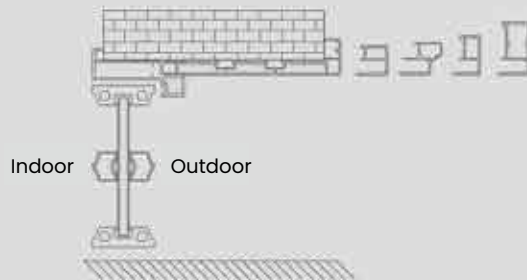

Through the harmonious fusion of light, shadow, and artistic design, the Ezzodoors Retro Glass Swing Door becomes a statement piece within the space—delivering a striking and refined visual experience.



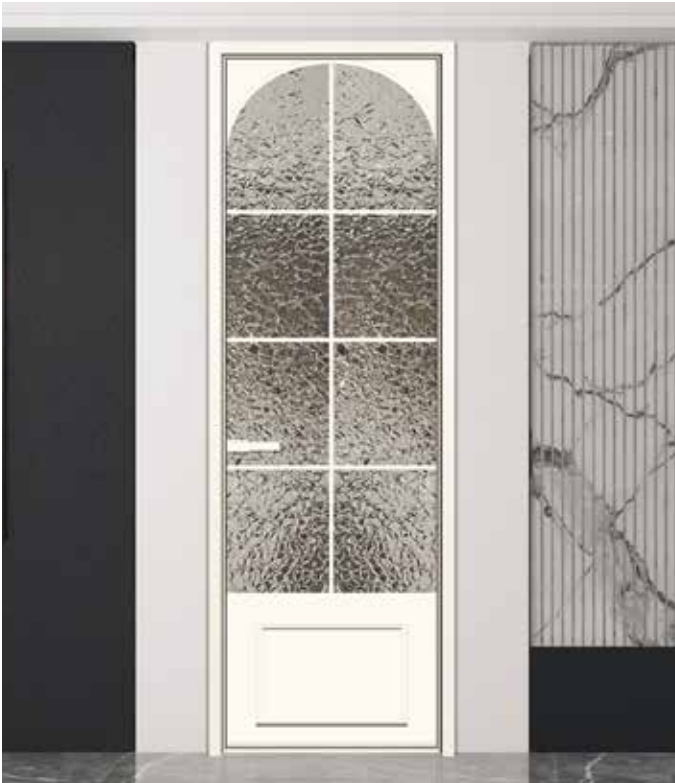

A harmonious fusion of light, shadow, and art—the Ezzodoors Retro Glass Swing Door transforms space into a stunning visual statement.

Quiet rather than ostentatious, it reveals beauty with subtle elegance—creating a space that feels calm, inviting, and truly worth coming home to.



# ITALIAN STYLE FLEXIBLE DOOR SERIES



ZM18



ZMX4

## ITALIAN STYLE FLEXIBLE DOOR ASSEMBLY DIAGRAM

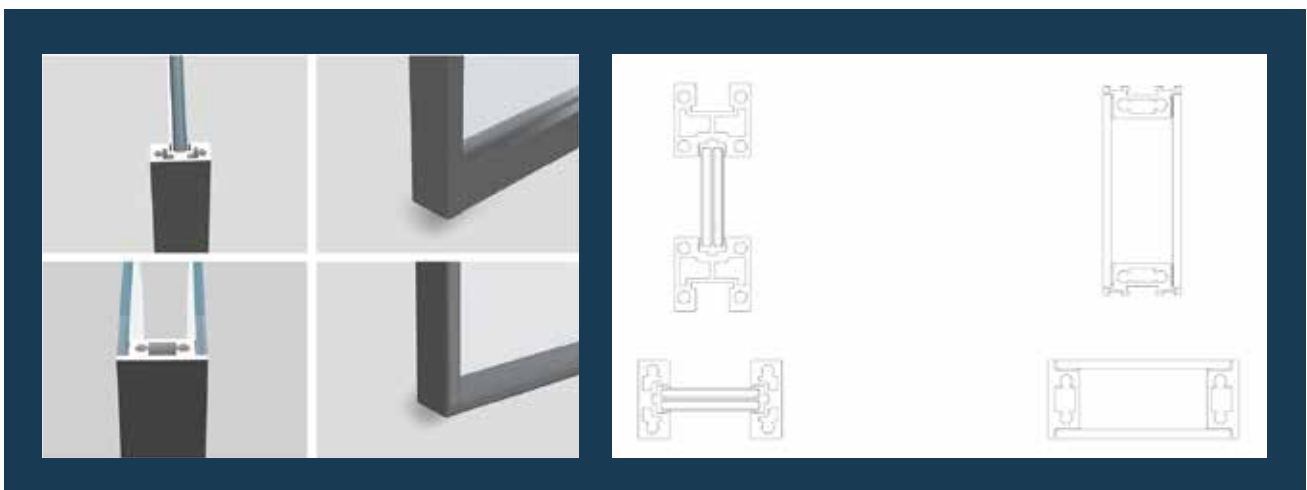

Like a hidden doorway within the home, it creates a refined and intimate space where tranquility and design meet. Whether placed in the kitchen, living room, or study, the Ezzodoors Revolving Door introduces a distinctive charm and a touch of playful elegance to the interior.



A hidden doorway within the home—bringing tranquility, elegance, and a unique sense of charm to kitchens, living rooms, and study spaces.



## MINIMALIST AXIS GATE

Crafted from high-quality aluminum alloy and processed with advanced techniques, these partition doors deliver exceptional decorative appeal. Available in a variety of colors and designs with a refined glossy finish, the slim frame structure allows for large panel configurations, maximizing versatility for different spaces. Modern, elegant, and highly functional, they enhance both the aesthetics and practicality of contemporary interiors.



# ITALIAN MULI SERIES



60-9 Outward-opening  
concealed door (semi-enclosed)

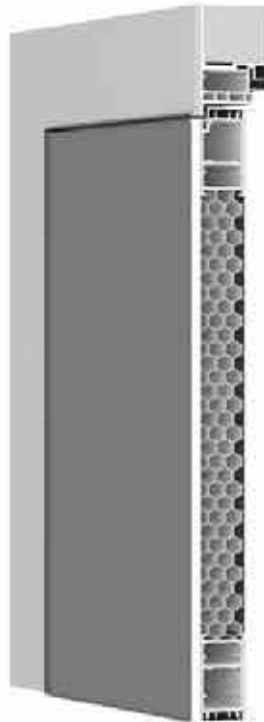

60mm plastering with flat exterior  
and open interior + (9mm plywood)

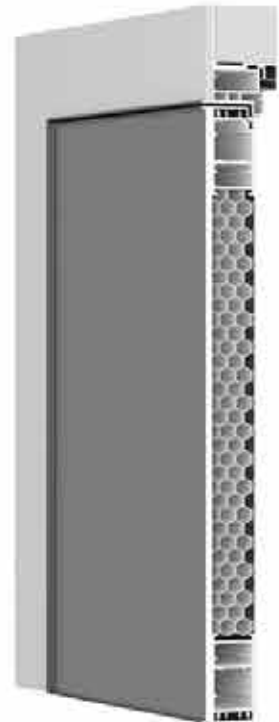

60mm plastering style with  
outward flatness and opening

## Italian-style wooden door series assembly diagram

60mm plastering with flat exterior and open interior + (9mm plywood)

Wall thickness  $\geq 59$

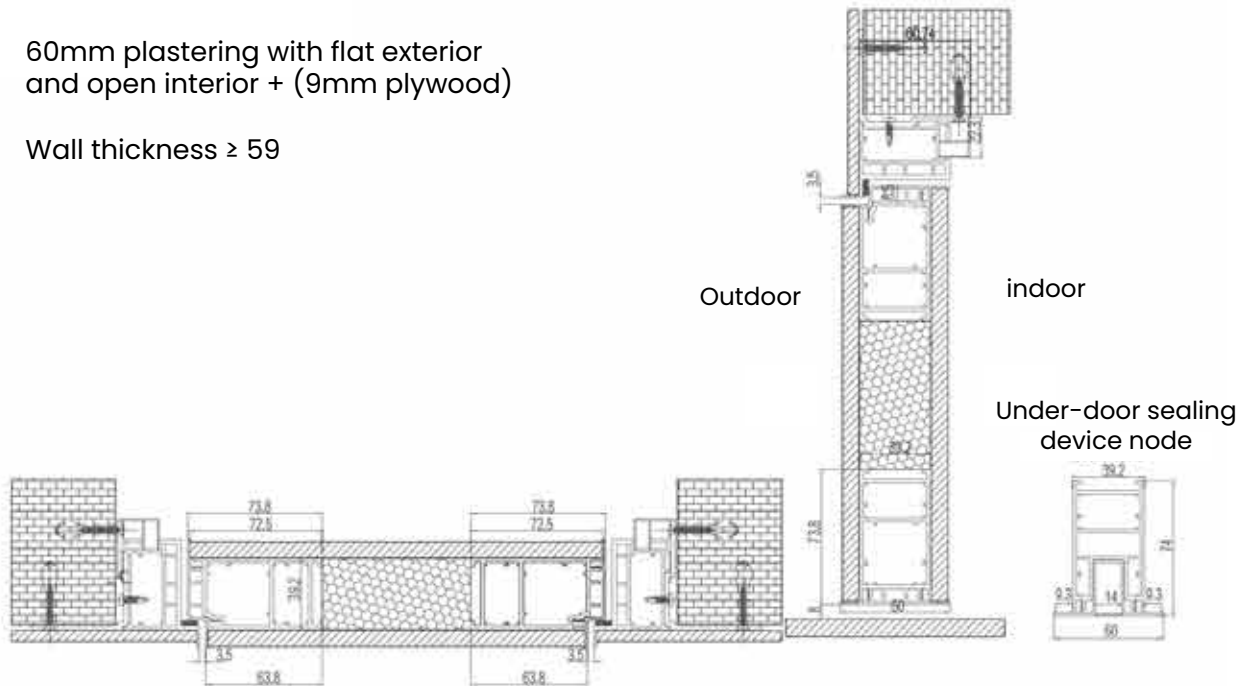

60mm plastering style with outward flatness and opening

Wall thickness  $\geq 59$

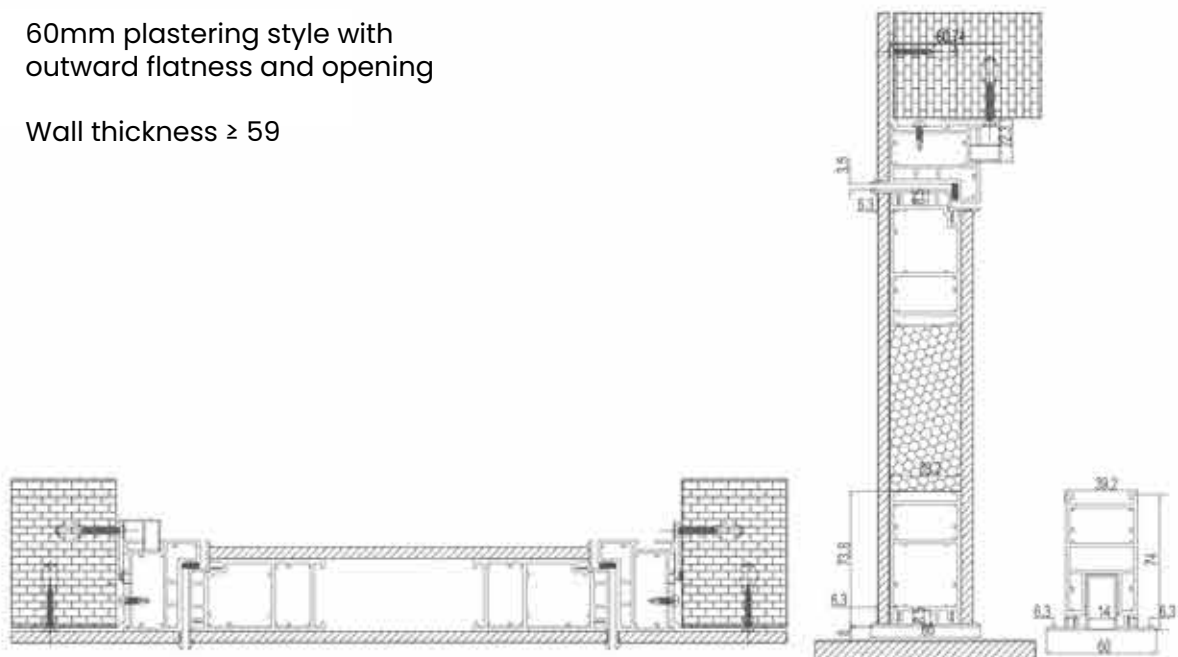



Like a hidden masterpiece within the home, it reveals a refined space where tranquility and design meet. Whether placed in the kitchen, living room, or study, the Ezzodors Revolving Door introduces a unique sense of charm and a touch of playful elegance.

The Ezzodors integrated door-and-wall design concept creates a seamless connection between door and wall, forming a clean and refined visual experience. This thoughtful design brings modern elegance while enhancing the sense of openness and spatial harmony within the home.





Where natural beauty meets modern design, a deeper charm unfolds within the space. The delicate surface texture enhances the essence of nature, revealing its beauty in its purest form while adding a unique and refined character to the environment.

A harmonious blend of natural beauty and modern design—delicate textures reveal nature's elegance while adding a unique charm to the space.



# ITALIAN INFINITE WIND SERIES



Italian style infinite dual-track



Italian infinite wind three tracks

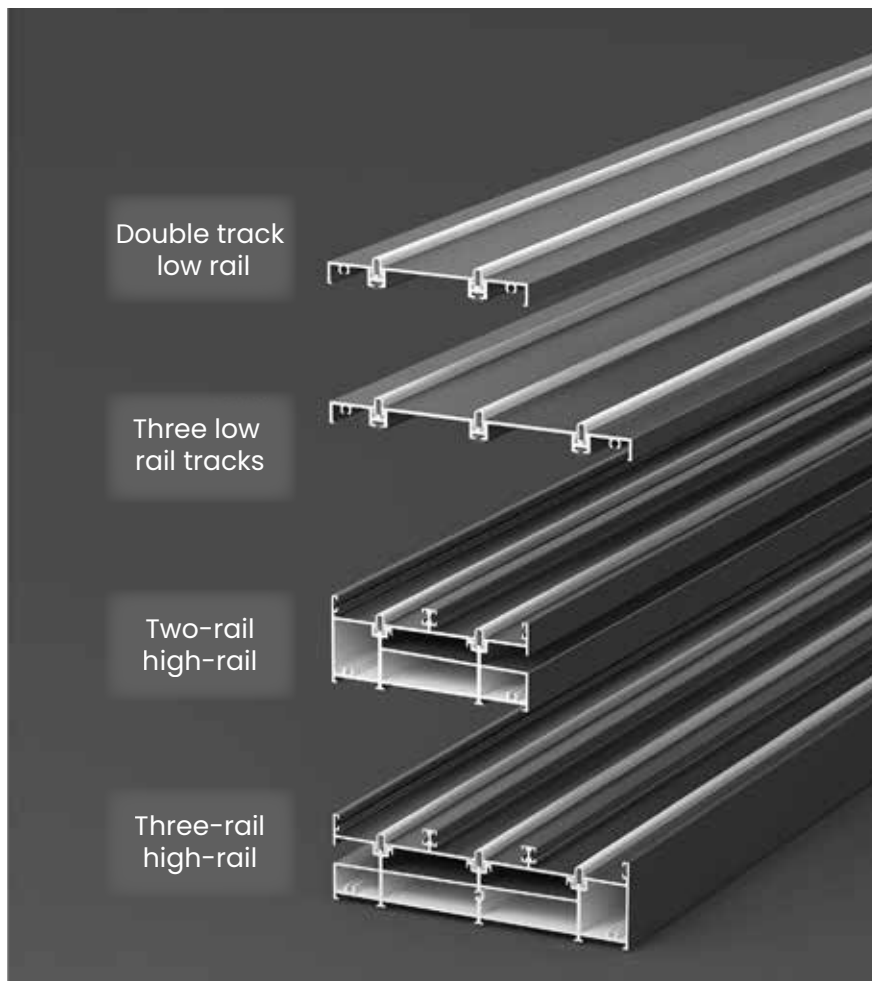

Designed for exceptional durability, the system maintains its stability in extreme temperatures—resisting deformation in heat and brittleness in cold conditions. Built to withstand severe weather, it provides dependable protection even during powerful Category 12 typhoons. The double-layer automotive-grade tempered glass panels allow generous natural light while delivering superior strength and safety.



In response to the demand of the domestic market, if the door opening is not completely vertical, we provide you with the following door sets. Integrate data parameters to solve the problem of gaps between doors and walls:

32 square sleeve line pressure wall: 9mm

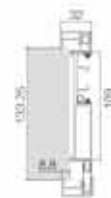

15 square sleeve line pressure wall: 15mm



45 square sleeve line pressure wall: 22mm



55 square sleeve line pressure wall: 32mm



#### Two track sliding door

**Wall thickness:** double-sided single-sided paneling, minimum thickness 133mm (using 32mm flat trim).

**Wall thickness:** double-sided single-sided paneling, minimum thickness 130mm (using 38/45/55 flat bead trim).

**Wall thickness:** single-sided semi-enclosed wall without panels, minimum thickness 115mm (using 32/38/45/55mm flat veneer).

#### Three track sliding door

**Wall thickness:** double-sided single-sided paneling, minimum thickness 183mm (using 32mm flat trim).

**Wall thickness:** double-sided single-sided paneling, minimum 180mm (using 38/45/55 flat bedding trim).

**Wall thickness:** single-sided semi-enclosed wall without panels, minimum thickness 170mm (using 32/38/45/55 flat bedding).

## Selective Colour



## Partial Glass Style



## Schematic Diagram of Opening Mode

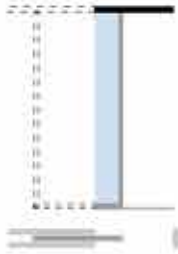

Single-track single-leaf wall-mounted sliding door, single-leaf wall-mounted magnetic levitation door

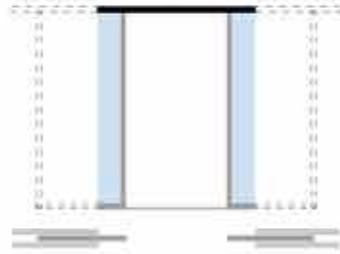

Single-track double-leaf wall-mounted sliding door, double-leaf wall-mounted magnetic levitation door

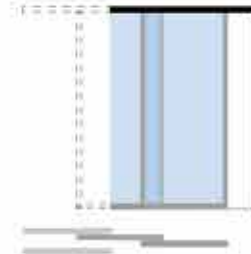

Linked wall-mounted sliding door

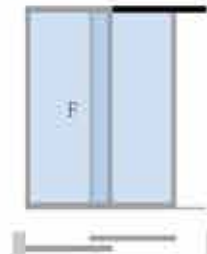

Single-leaf fixed sliding door

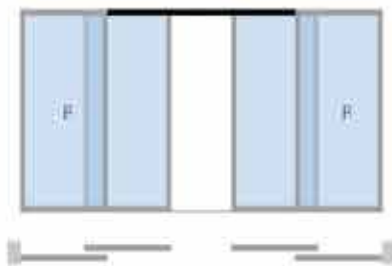

Two double-opening round sliding doors

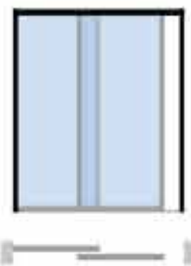

Two-track two-leaf sliding door; two-track single-leaf magnetic levitation door

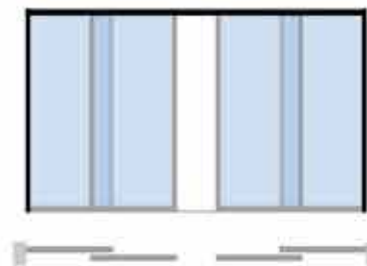

Two-track four-panel sliding door / Two-track double-leaf magnetic levitation door with opposite-direction linkage in the middle

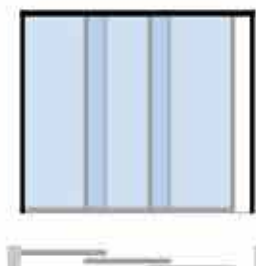

Three-linkage hanging sliding door

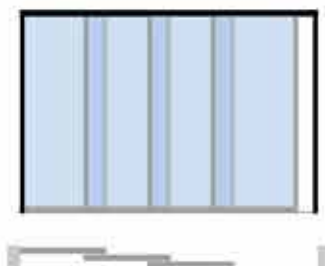

Four-linkage hanging sliding door

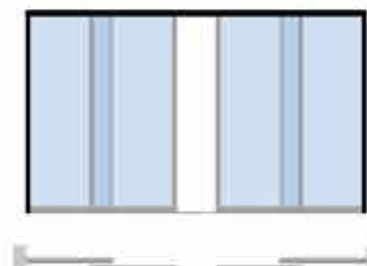

Two-track, four-panel sliding doors / Interlocking mechanism in the middle

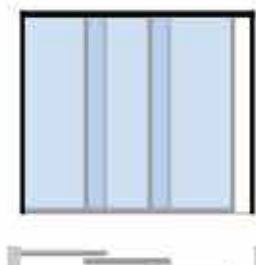

Triple linkage sliding door

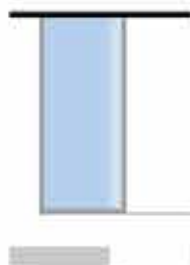

Single-track single-leaf sliding door

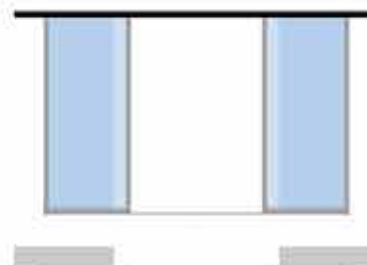

Single-track two-panel sliding door / sliding doors moving in opposite directions

## Schematic Diagram of Opening Mode

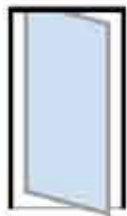

Manual revolving door

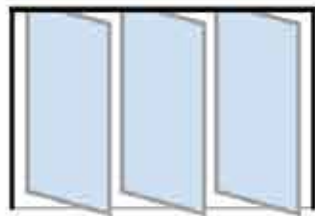

Manual revolving door



Electric revolving door

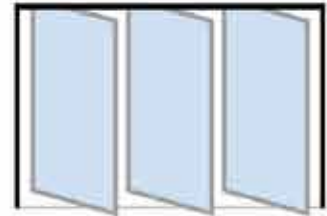

Electric revolving door

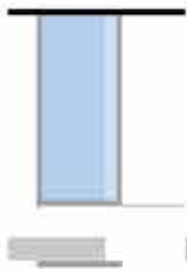

Single-track single-leaf sliding door

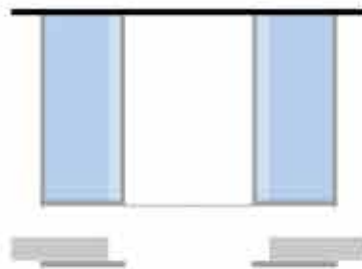

Single-track two-panel sliding door / sliding and moving motion linkage

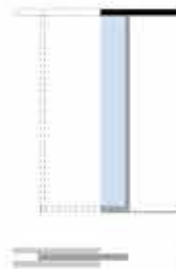

Single-track single-brush in-wall sliding door

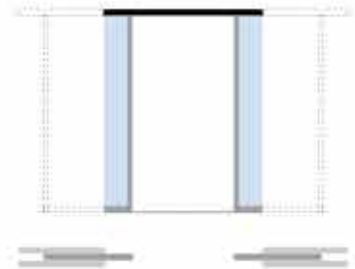

Single-track two-panel wall-mounted sliding door

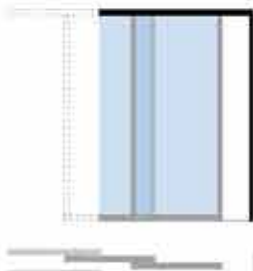

Two-link sliding door

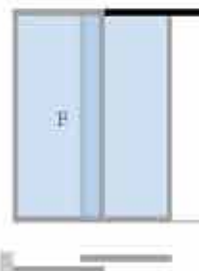

Single-leaf, single-fixed sliding door

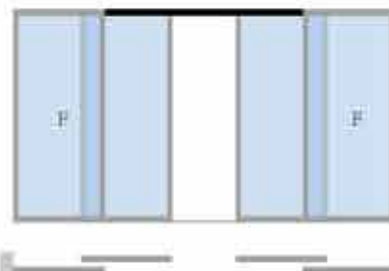

Two double-hinged sliding doors

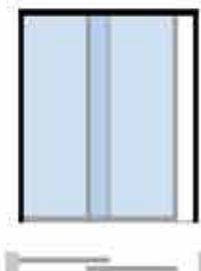

Two sliding doors on two tracks

## Schematic Diagram of Opening Mode

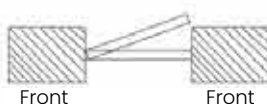

PK left inside

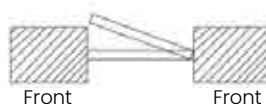

PK opens right inside

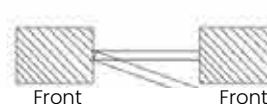

PK left outside

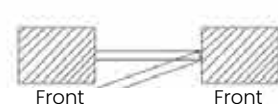

PK right outside



THANK YOU !

**Get in touch** with us



[admin@ezzogenics.com](mailto:admin@ezzogenics.com)  
[david@ezzogenics.com](mailto:david@ezzogenics.com)



9632 0750



6968 3098



Bartley Biz Centre,  
Blk 15 Kaki Bukit Rd 4, #01-44, S417808



[www.ezzodoorss.com](http://www.ezzodoorss.com)